



LDMOS RF Power-Amplifier Bias Controller

DS1870

General Description

The DS1870 is a dual-channel bias controller targeted toward class AB LDMOS RF power-amplifier applications. It uses lookup tables (LUTs) to control 256-position potentiometers based on the amplifier's temperature and drain voltage or current (or other external monitored signal). With its internal temperature sensor and multichannel A/D converter (ADC), the DS1870 provides a cost-effective solution that improves the amplifier's efficiency by using nonlinear compensation schemes that are not possible with conventional biasing solutions.

Applications

- Cellular Base Stations
- Medical Equipment
- Industrial Controls
- Optical Transceivers

I²C is a trademark of Philips Corp. Purchase of I²C components of Maxim Integrated Products, Inc., or one of its sub-licensed Associated Companies, conveys a license under the Philips I²C Patent Rights to use these components in an I²C system, provided that the system conforms to the I²C Standard Specification as defined by Philips.

Features

- ◆ Two-Channel Solution for Programmable RF Bias Control
- ◆ The Potentiometer's Position is Automatically Updated to Compensate for the Ambient Temperature and the Drain Voltage or Current
- ◆ A Five-Channel, 13-Bit ADC Continuously Monitors the Ambient Temperature, V_{CC}, V_D, I_{D1}, and I_{D2}
- ◆ Hi/Lo Alarms for Each ADC Channel can Trigger a Fault Output
- ◆ Nonvolatile Memory for the Device Settings, Lookup Tables, and 32-Bytes of User Memory
- ◆ I²C™-Compatible Serial Interface with Up to Eight Devices on the Same Serial Bus
- ◆ Single 5V Power Supply
- ◆ Small 16-Pin TSSOP Package
- ◆ -40°C to +95°C Operational Temperature Range

Ordering Information

PART	TEMP RANGE	PIN-PACKAGE
DS1870E-010	-40°C to +95°C	16 TSSOP (173 mil)

Typical Operating Circuit appears at end of data sheet.

Pin Configuration

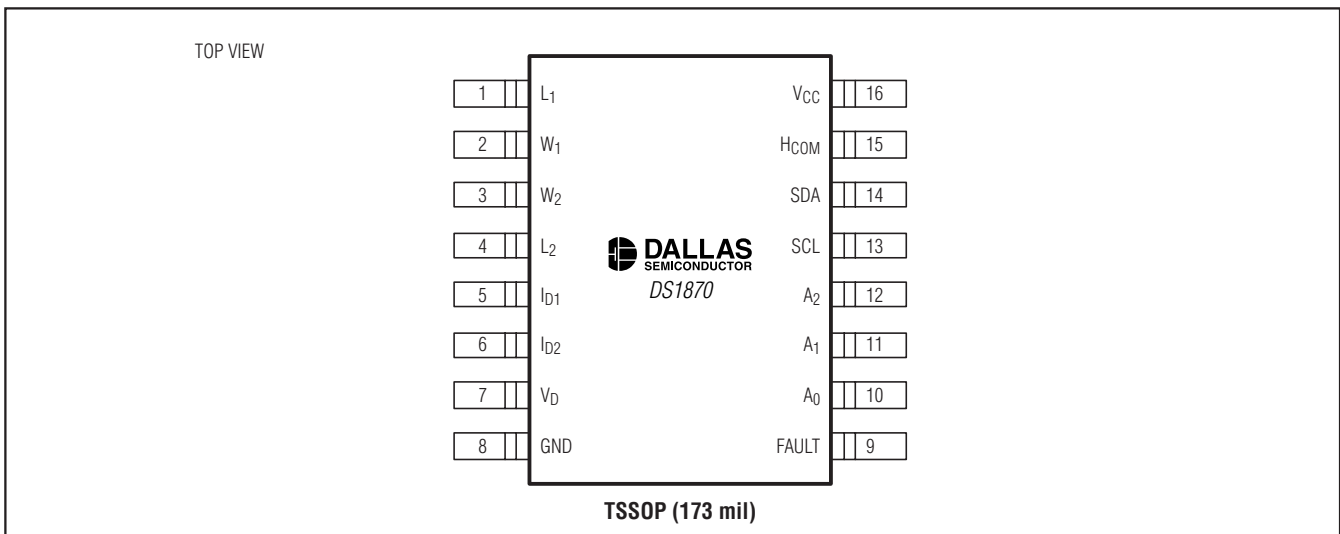

LDMOS RF Power-Amplifier Bias Controller

ABSOLUTE MAXIMUM RATINGS

Voltage Range on V_{CC}, H_{COM}, SDA, and SCL Pins Relative to Ground-0.5V to +6.0V
 Voltage Range on A₀, A₁, A₂, FAULT, V_D, I_{D1}, I_{D2} Relative to Ground-0.5V to V_{CC} + 0.5V, not to exceed +6.0V
 Voltage Range on L₀, L₁, W₀, and W₁ Relative to Ground-0.5V to H_{COM} + 0.5V, not to exceed +6.0V

Operating Temperature Range-40°C to +95°C
 EEPROM Programming Temperature Range0°C to +70°C
 Storage Temperature Range-55°C to +125°C
 Soldering TemperatureSee IPC/JEDEC J-STD-020A Specification

Stresses beyond those listed under "Absolute Maximum Ratings" may cause permanent damage to the device. These are stress ratings only, and functional operation of the device at these or any other conditions beyond those indicated in the operational sections of the specifications is not implied. Exposure to absolute maximum rating conditions for extended periods may affect device reliability.

RECOMMENDED DC OPERATING CONDITIONS

(T_A = -40°C to +95°C)

PARAMETER	SYMBOL	CONDITIONS	MIN	TYP	MAX	UNITS
Supply Voltage	V _{CC}	(Note 1)	4.5		5.5	V
Input Logic 1 (SDA, SCL, A ₂ , A ₁ , A ₀)	V _{IH}		0.7 x V _{CC}		V _{CC} + 0.3	V
Input Logic 0 (SDA, SCL, A ₂ , A ₁ , A ₀)	V _{IL}		-0.3		+0.3 x V _{CC}	V
H _{COM} Voltage			4.5		5.5	V
L _X and W _X Voltage			-0.3		H _{COM} + 0.3	V
Wiper Current			-1		+1	mA

DC ELECTRICAL CHARACTERISTICS

(V_{CC} = +4.5 to 5.5V, T_A = -40°C to +95°C.)

PARAMETER	SYMBOL	CONDITIONS	MIN	TYP	MAX	UNITS
Supply Current	I _{CC}	(Note 2)		1	2	mA
Input Leakage	I _{LI}		-200		+200	nA
Low-Level Output Voltage (SDA, FAULT)	V _{OL1}	3mA sink current			0.4	V
	V _{OL2}	6mA sink current			0.6	V
I/O Capacitance	C _{I/O}				10	pF
Digital Power-On Reset	V _{POD}		1.0		2.2	V
Analog Power-On Reset	V _{POA}		2.0		2.8	V

LDMOS RF Power-Amplifier Bias Controller

DS1870

ANALOG VOLTAGE-MONITORING CHARACTERISTICS

(V_{CC} = +4.5 to 5.5V, T_A = -40°C to +95°C.)

PARAMETER	SYMBOL	CONDITIONS	MIN	TYP	MAX	UNITS
V _D Monitor Factory-Calibrated FS		Code FFF8h	2.488	2.500	2.513	V
V _{CC} Monitor Factory-Calibrated FS		Code FFF8h	6.521	6.553	6.587	V
I _{D1} and I _{D2} Monitor Factory-Calibrated FS		Code FFF8h	0.4975	0.5000	0.5025	V
Resolution (V _{CC} , V _D , I _{D1} , I _{D2})				0.0122		%FS
Accuracy (V _{CC} , V _D , I _{D1} , I _{D2})				0.25	0.5	%FS
Update Rate for V _{CC} , V _D , I _{D1} , I _{D2}	t _{frame}			50		ms

DIGITAL THERMOMETER CHARACTERISTICS

(V_{CC} = +4.5 to 5.5V, T_A = -40°C to +95°C.)

PARAMETER	SYMBOL	CONDITIONS	MIN	TYP	MAX	UNITS
Thermometer Error	T _{ERR}	-40°C to 95°C	-3		+3	°C
Update Rate	t _{frame}			50		ms

ANALOG POTENTIOMETER CHARACTERISTICS

(V_{CC} = +4.5 to 5.5V, T_A = -40°C to +95°C.)

PARAMETER	SYMBOL	CONDITIONS	MIN	TYP	MAX	UNITS
Wiper Resistance		+25°C		500	1000	Ω
Potentiometer End-to-End Resistance	R _{POT}	+25°C	10.0	13	16.8	kΩ
Resolution				0.4		%FS
Absolute Linearity		(Note 3)	-1		+1	LSB
Relative Linearity		(Note 4)	-0.5		+0.5	LSB
Ratiometric Temperature Coefficient				5		ppm/°C
End-to-End Temperature Coefficient				70		ppm/°C
-3dB Cutoff Frequency		(Note 5)		1		MHz
Series Resistors from L1, L2 to GND	R _S	+25°C	15.1	19.5	25.2	kΩ
V _{HCOM} /V _{LX}			0.5975	0.6	0.6025	

LDMOS RF Power-Amplifier Bias Controller

LOOKUP TABLE CHARACTERISTICS

(V_{CC} = +4.5 to 5.5V, T_A = -40°C to +95°C.)

PARAMETER	SYMBOL	CONDITIONS	MIN	TYP	MAX	UNITS
POT1 and POT2 Temp LUT Size				72		Bytes each
POT1 and POT2 Temp LUT Index Range			-40		+102	°C
Temp Step				2		°C
Temp Hysteresis		(Note 6)		1		°C
POT1 and POT2 Drain LUT Size				64		Bytes each
POT1 and POT2 Drain LUT V _D Index Range			8000		FE00	Hex
POT1 and POT2 Drain LUT V _D Step				0200		Hex
POT1 and POT2 Drain LUT V _D Hysteresis		(Note 6)		0100		Hex
POT1 and POT2 Drain LUT I _{DX} Index Range			0000		7E00	Hex
POT1 and POT2 Drain LUT I _{DX} Step				0200		Hex
POT1 and POT2 Drain LUT I _{DX} Hysteresis		(Note 6)		0100		Hex

LDMOS RF Power-Amplifier Bias Controller

DS1870

AC ELECTRICAL CHARACTERISTICS

($V_{CC} = +4.5V$ to $5.5V$, $T_A = -40^{\circ}C$ to $+95^{\circ}C$, timing referenced to $V_{IL(MAX)}$ and $V_{IH(MIN)}$.) (Figure 3)

PARAMETER	SYMBOL	CONDITIONS	MIN	TYP	MAX	UNITS
SCL Clock Frequency	f_{SCL}	(Note 7)	0		400	kHz
Bus Free Time Between Stop and Start Conditions	t_{BUF}		1.3			μs
Hold Time (Repeated) Start Condition	$t_{HD:STA}$		0.6			μs
Low Period of SCL	t_{LOW}		1.3			μs
High Period of SCL	t_{HIGH}		0.6			μs
Data Hold Time	$t_{HD:DAT}$		0		0.9	μs
Data Setup Time	$t_{SU:DAT}$		100			ns
Start Setup Time	$t_{SU:STA}$		0.6			μs
SDA and SCL Rise Time	t_R	(Note 8)	20 + 0.1 C_B		300	ns
SDA and SCL Fall Time	t_F	(Note 8)	20 + 0.1 C_B		300	ns
Stop Setup Time	$t_{SU:STO}$		0.6			μs
SDA and SCL Capacitive Loading	C_B	(Note 8)			400	pF
EEPROM Write Time	t_W	(Note 9)		10	20	ms

NONVOLATILE MEMORY CHARACTERISTICS

($V_{CC} = +4.5V$ to $5.5V$, $T_A = 0^{\circ}C$ to $+70^{\circ}C$.)

PARAMETER	SYMBOL	CONDITIONS	MIN	TYP	MAX	UNITS
Writes		$+70^{\circ}C$ (Note 5)	50,000			

Note 1: All voltages referenced to ground.

Note 2: Supply current is measured with all logic inputs at their inactive state ($SDA = SCL = V_{CC}$) and driven to well-defined logic levels. All outputs are disconnected.

Note 3: Absolute linearity is the difference of measured value from expected value at the DAC position. Expected value is a straight line from measured minimum position to measured maximum position.

Note 4: Relative linearity is the deviation of an LSB DAC setting change vs. the expected LSB change. Expected LSB change is the slope of the straight line from measured minimum position to measured maximum position.

Note 5: This parameter is guaranteed by design.

Note 6: See Figure 1.

Note 7: I²C interface timing shown is for fast-mode (400kHz) operation. This device is also backward compatible with I²C standard-mode timing.

Note 8: C_B —total capacitance of one bus line in picofarads.

Note 9: EEPROM write begins after a stop condition occurs.

LDMOS RF Power-Amplifier Bias Controller

Typical Operating Characteristics

($V_{CC} = +5.0V$, $T_A = +25^{\circ}C$, unless otherwise noted.)

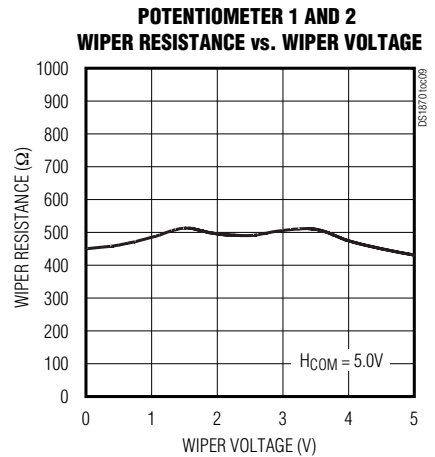
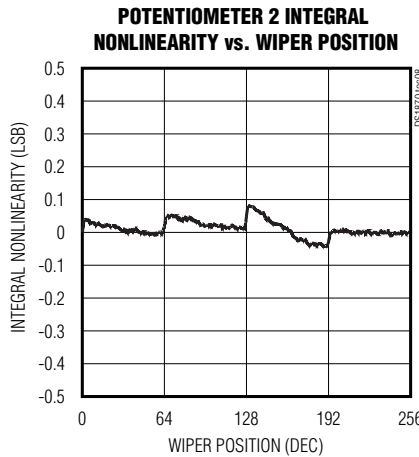
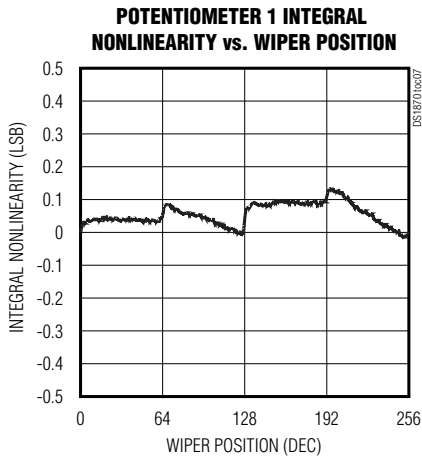
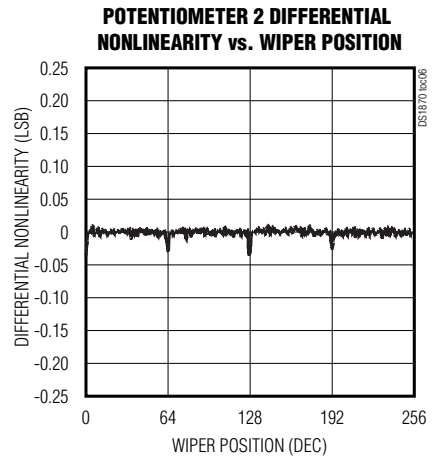
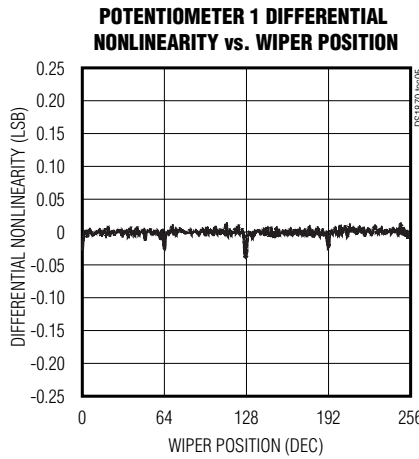
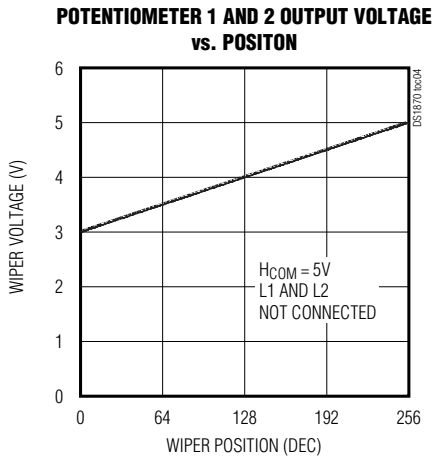
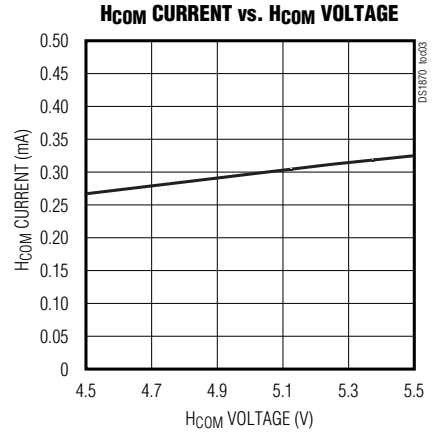
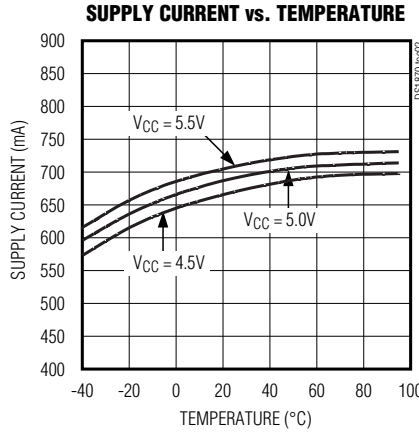
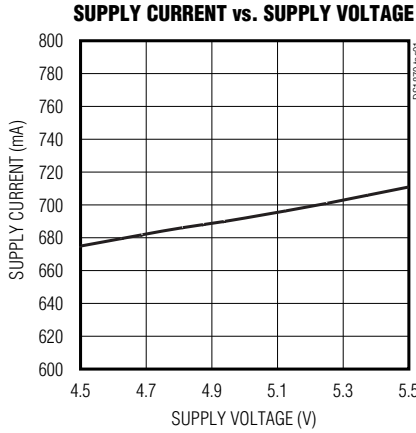

LDMOS RF Power-Amplifier Bias Controller

DS1870

Typical Operating Characteristics (continued)

($V_{CC} = +5.0V$, $T_A = +25^\circ C$, unless otherwise noted.)

**POTENTIOMETER 1 AND 2
WIPER RESISTANCE vs. WIPER VOLTAGE**

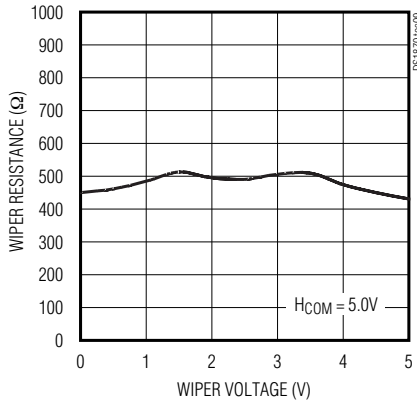

**POTENTIOMETER 1 AND 2
WIPER RESISTANCE vs. TEMPERATURE**

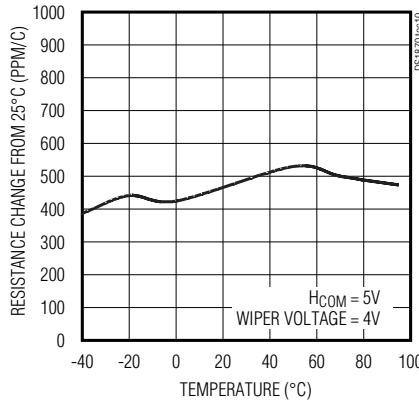

**POTENTIOMETER END-TO-END RESISTANCE
vs. TEMPERATURE**

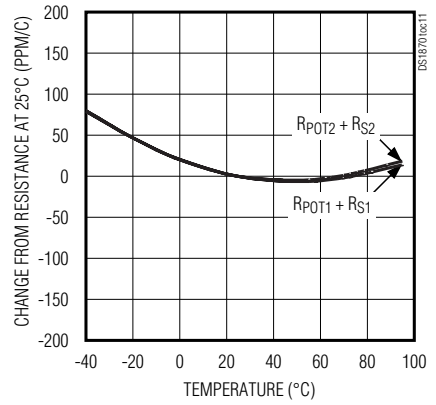

**POTENTIOMETER LOW TERMINAL VOLTAGE
vs. TEMPERATURE**

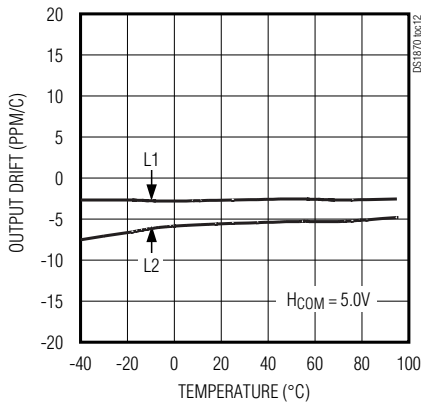

**V_{CC} CONVERSION ERROR
vs. SUPPLY VOLTAGE**

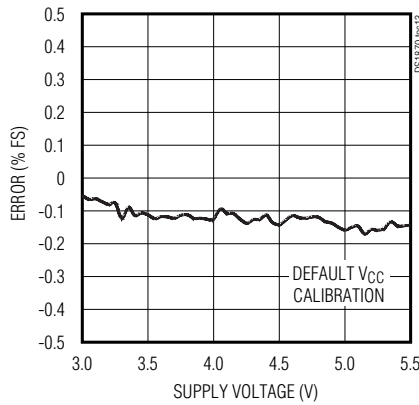

**VD CONVERSION ERROR
vs. INPUT VOLTAGE**

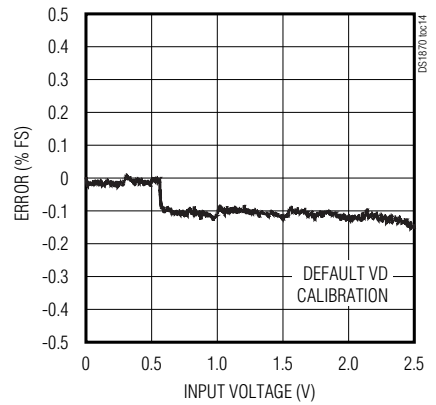

**ID1 CONVERSION ERROR
vs. INPUT VOLTAGE**

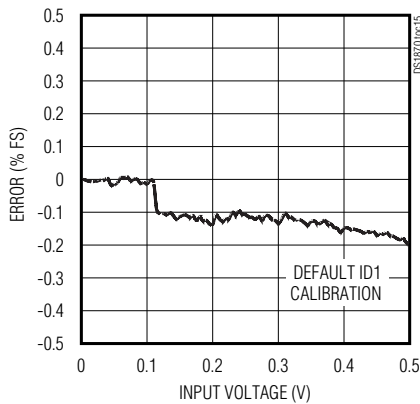

**ID2 CONVERSION ERROR
vs. INPUT VOLTAGE**

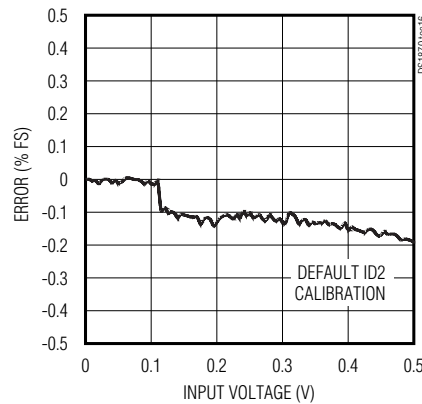

LDMOS RF Power-Amplifier Bias Controller

Pin Description

PIN	NAME	FUNCTION
1	L ₁	Potentiometer 1 Low Terminal
2	W ₁	Potentiometer 1 Wiper Terminal
3	W ₂	Potentiometer 2 Wiper Terminal
4	L ₂	Potentiometer 2 Low Terminal
5	ID ₁	Drain Current 1 Monitor Input
6	ID ₂	Drain Current 2 Monitor Input
7	V _D	Drain Voltage Monitor Input
8	GND	Ground
9	FAULT	Fault Output. This open-collector output is active high when one of the enabled alarms is outside its programmable limit value.
10	A ₀	I ² C Address Inputs. These inputs determine the slave address of the device. The slave address in binary is 1010A ₂ A ₁ A ₀ .
11	A ₁	
12	A ₂	
13	SCL	Serial Clock Input. I ² C clock input.
14	SDA	Serial Data Input/Output. Bidirectional I ² C data pin.
15	HCOM	Potentiometer High Terminal. Common to potentiometers 1 and 2.
16	VCC	Power Input

LDMOS RF Power-Amplifier Bias Controller

Functional Diagram

DS1870

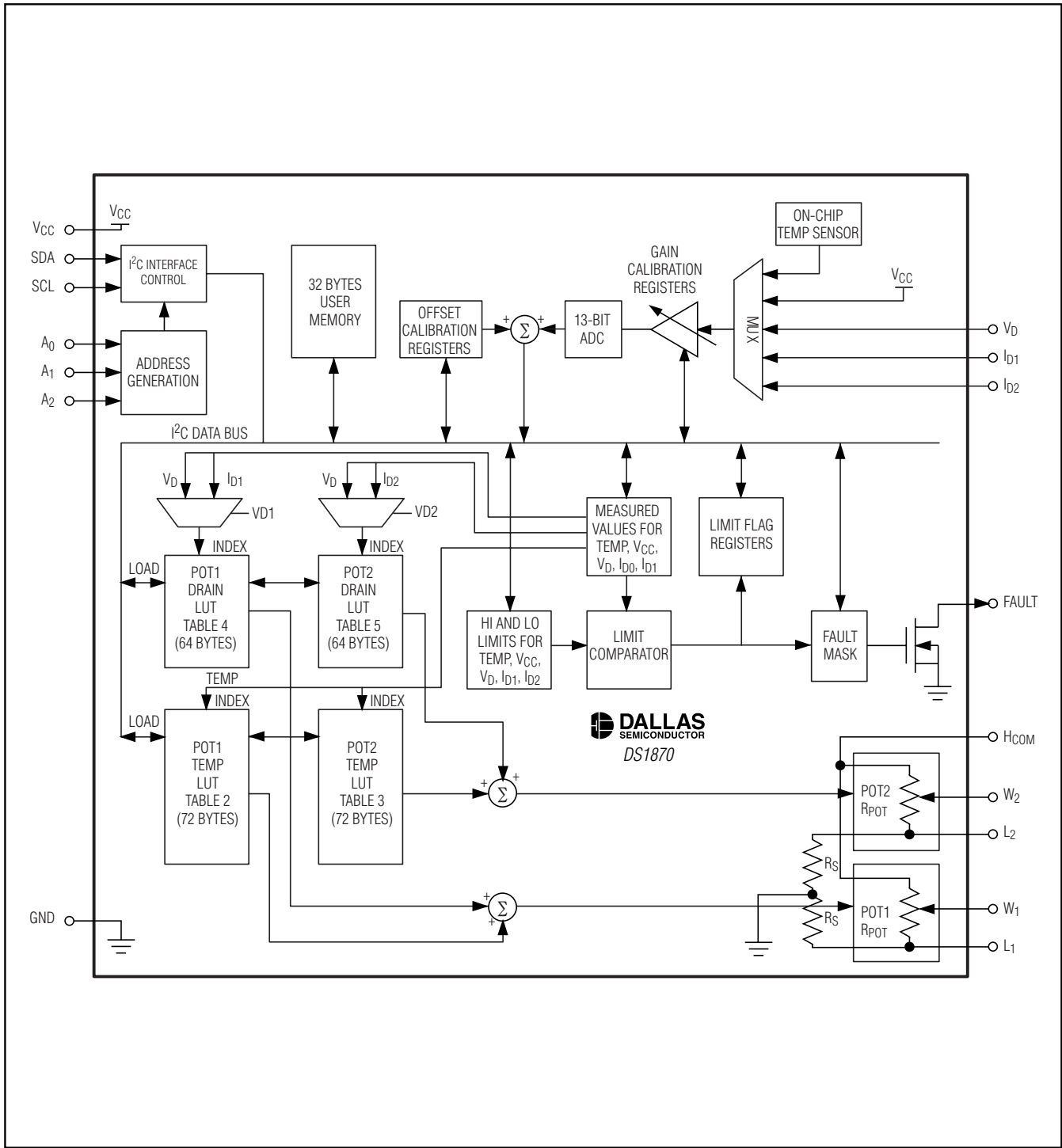

LDMOS RF Power-Amplifier Bias Controller

Table 1. Voltage-Monitor Factory Default Calibration

SIGNAL	+FS SIGNAL	+FS (hex)	-FS SIGNAL	-FS (hex)
V _{CC}	6.553V	FFF8	0V	0000
V _D	2.5V	FFF8	0V	0000
I _{D1}	0.5V	FFF8	0V	0000
I _{D2}	0.5V	FFF8	0V	0000

Detailed Description

The DS1870 is a dual-channel LDMOS bias controller. It is intended to replace traditional bias control solutions that are limited by a constant temperature-coefficient correction. This IC offers lookup table correction that is programmable as a function of temperature as well as drain supply voltage or current. The flexibility to use a nonlinear bias correction improves efficiency significantly. This is a direct consequence of the ability to lower the bias current, particularly in class AB operation, since the bias correction no longer requires a constant temperature coefficient. In addition, correcting the bias as a function of drain supply voltage, or drain current in class AB, assists in distortion reduction and gain management.

Two outputs (W1 and W2), each controlled by a dedicated two-dimensional lookup table as shown in the functional diagram, drive two LDMOS gates. The two degrees of freedom are temperature and either drain supply voltage or drain current. The lookup tables are programmed during power-amplifier assembly and test. After calibration, the IC automatically recalls the proper control setting for each output, based on temperature and drain characteristics.

A 13-bit ADC samples and digitizes the chip temperature, V_{CC}, the drain supply voltage, and two drain currents. These digitized signals are stored in memory ready to be accessed by the look up table controls. The digitized values are also compared to alarm thresholds generating high or low alarm flags. The FAULT output can be configured to assert high based on any alarm's assertion, or the alarms can be masked to prevent unwanted fault assertions. The ADC readings as well as the alarm flags and fault status are accessible through the I²C-compatible interface.

Voltage/Current Monitor Operation

The DS1870 monitors four voltages (V_{CC}, V_D, I_{D1}, and I_{D2}) plus the temperature in a round-robin fashion using its 13-bit ADC. The converted voltage values are stored in memory addresses 62h–69h as 16-bit unsigned numbers with the ADC result left justified in the register.

Table 2. Voltage-Monitor Conversion Examples

SIGNAL	LSB WEIGHT (μV)	REGISTER VALUE (hex)	INPUT VOLTAGE (V)
V _{CC}	100.00	8080	3.29
V _{CC}	100.00	C0F8	4.94
V _D	38.152	C000	1.875
V _D	38.152	8080	1.255
I _{D1}	7.6303	8000	0.2500
I _{D2}	7.6303	1328	0.0374

The three least significant bits of the ADC result registers are masked to zero. The round-robin time is specified by t_{frame} in the analog voltage-monitoring characteristics.

The default factory-calibrated values for the voltage monitors are shown in Table 1.

To calculate the voltage measured from the register value, first calculate the LSB weight of the 16-bit register that is equal to the full-scale voltage span divided by 65,528. Next, convert the hexadecimal register value to decimal and multiply it times the LSB weight.

Example: Using the factory default V_{CC} trim, what voltage is measured if the V_{CC} register value is C347h? The LSB for V_{CC} is equal to $(6.553V - 0V) / 65,528 = 100.00\mu V$. C347h is equal to 49,991 decimal, which yields a supply voltage equal to $49,991 \times 100.00\mu V = 4.999V$. Table 2 shows more conversion examples based on the factory trimmed ADC settings.

By using the internal gain and offset calibration registers, the +FS and -FS signal values shown in Table 1 can be modified to meet customer needs. For more information on calibration, see the *Voltage/Temperature Monitor Calibration* section.

Note: The method shown above for determining the input voltage level only works when the offset register is set to zero.

LDMOS RF Power-Amplifier Bias Controller

DS1870

Table 3. Internal Temperature-Monitor Factory Default Calibration

SIGNAL	+FS SIGNAL	+FS (hex)	-FS SIGNAL	-FS (hex)
Temp	+127.97°C	7FF8	-128.00°C	8000

Temperature-Monitor Operation

The internal temperature monitor values are stored as 16-bit 2's complement numbers at memory addresses 60h to 61h. The round-robin update time (t_{frame}) for the temperature register is the same as the voltage monitors. The factory default calibration values for the temperature monitor are shown in Table 3.

To convert the 2's complement register value to the temperature it represents, first convert the 2-byte hexadecimal value to a decimal value as if it is an unsigned value, then divide the result by 256. Finally, subtract 256 if the result of the division is greater than or equal to +128. Table 4 shows example converted values.

The offset of the temperature sensor can be adjusted using the internal calibration registers to account for differences between the ambient temperature at the location of the DS1870 and the temperature of the device it is biasing. When offsets are applied to the temperature measurement, the value converted will be off by a fixed value from the DS1870's ambient temperature. For more information, see the *Temperature Monitor Offset Calibration* section.

Potentiometer Operation

Both of the DS1870's potentiometers are 256 positions with their high terminals connected to the high common pin, HCOM. The low terminals of the potentiometers are internally shunted to GND by resistors such that the output voltage is 3V to 5V when HCOM is connected to a 5V source. The internal shunt resistors and the potentiometer's end-to-end resistance feature matching temperature coefficients that prevent the output voltage from drifting over temperature.

External resistors can be placed from HCOM to Lx and/or from Lx to GND to modify the typical output voltage.

Normal Operation

During normal operation, each potentiometer's position is automatically adjusted to the sum of its temperature and drain LUT values after each round of conversions. The potentiometer setting is applied after both the base and offset LUT values are recalled from memory. The sum of the currently indexed values in the POT1 Temp LUT (memory table 2) and the POT1 Drain LUT (memory table 4) control potentiometer 1. The sum of the currently indexed values in the POT2 Temp LUT (memory

Table 4. Temperature Conversion Values

MSB (bin)	LSB (bin)	TEMPERATURE (°C)
01000000	00000000	+64
01000000	00001111	+64.059
01011111	00000000	+95
11110110	00000000	-10
11011000	00000000	-40

Table 5. LUT Addresses for Corresponding Temperature Values

LUT ADDRESS (hex)	CORRESPONDING TEMPERATURE (°C)
80	≤ -40°C
81	-38°C
82	-36°C
...	...
C6	+100°C
C7	≥ +102°C

table 3) and the POT2 Drain LUT (memory table 5) control potentiometer 2. In the event that two table values are summed and the result is greater than 255 or less than 0, the potentiometer's position is set to 255 or 0, respectively.

LDMOS RF Power-Amplifier Bias Controller

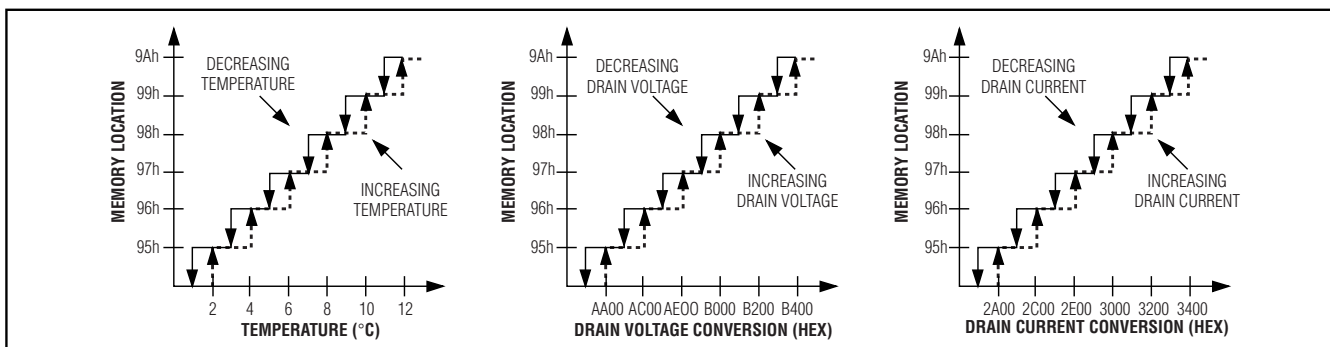

Figure 1. LUT Hysteresis

The temperature tables (LUT 2 and LUT 3) are 72 bytes each. This allows the biasing to be adjusted every 2°C between -40°C and +102°C. Temperatures less than -40°C or greater than 102°C use the -40°C or 102°C values, respectively. The values in the temperature tables are 8-bit unsigned values (0 to 255 decimal) that allow the potentiometer to be set to any position as a function of the temperature. The temperature LUTs have 1°C hysteresis (Figure 1) to prevent the potentiometer's position from chattering in the event the temperature remains near a LUT switching point. Table 5 shows how the DS1870 determines the temperature tables index as a function of temperature.

The drain tables (LUT 4 and LUT5) are 64 bytes each, and they can be indexed either by the drain voltage or the drain current corresponding to the potentiometer. The VD1 control bit determines if the voltage sensed on V_D or I_{D1} adjusts the POT1 Drain LUT, and the VD2 control bit determines if the voltage sensed on V_D or I_{D2} controls the POT2 Drain LUT. The VD1 and VD2 control bits are located in register 85h of memory table 1. The drain tables are programmed with an 8-bit signed value (-128 to +127 decimal) that allow a relative offset from the temperature LUT values determined by the amplifier's drain characteristics.

Table 6. LUT Addresses for V_D or I_{DX} Values

LUT ADDRESS (hex)	V _D VALUE (hex)	I _{DX} VALUE (hex)
80	≤ 8000	0000
81	8200	0200
82	8400	0400
...
BE	FC00	7C00
BF	≥ FE00	≥ 7E00

The drain LUTs are indexed either by the upper half of the V_D range or the lower half of its corresponding I_{DX} range. Table 6 shows how the index is determined based on the V_D or I_{DX} values. Hysteresis equal to 0100h is also implemented on the drain monitor (Figure 1) to ensure that voltages close to a switching point do not cause the potentiometer position to chatter between two LUT values. The drain LUT index values are specified in hexadecimal because the hexadecimal values are applicable regardless of the gain and offset calibration of the DS1870.

Manual Mode

During normal operation, the potentiometer position is automatically modified once per conversion cycle based on the ADC results. The DS1870 can either stop the update function all together by using the B/O_en bit, or the temperature and drain LUT indexes can be manually controlled by using the Index_en bit. These bits are located in the Man DAC register located in memory table 1, byte AFh. More information about these bits is in the *Register Description* section.

Voltage-Monitor Calibration

The DS1870 can scale each analog voltage's gain and offset to produce the desired digital result. Each of the inputs (V_{CC}, V_D, I_{D1}, I_{D2}) has a unique register for the gain and offset (in memory table 1) allowing them to be individually calibrated. Additionally, the DS1870 offers the ability to provide a temperature offset to allow the temperature measurement to be compensated to account for the difference in temperature between the DS1870 and the device it is biasing.

To scale the gain and offset of the converter for a specific input, you must first know the relationship between the analog input and the expected digital result. The input that would produce a digital result of all zeros is the null value (normally this input is GND). The input that would produce a digital result of all ones (FFF8h) is

LDMOS RF Power-Amplifier Bias Controller

the full-scale (FS) value. The expected FS value is also found by multiplying an all-ones digital answer by the LSB weight.

Example: Since the FS digital reading is 65,528 (FFF8 hex) LSBs, if the LSB's weight is 50 μ V, then the FS value is 65,528 x 50 μ V = 3.2764V.

A binary search is used to calibrate the gain of the converter. This requires forcing two known voltages to the input pin. It is preferred that one of the forced voltages is the null input and the other is 90% of FS. Since the LSB of the least significant bit in the digital reading register is known, the expected digital results can be calculated for both the null input and the 90% of full scale value.

An explanation of the binary search used to scale the gain is best served with the following example pseudo-code:

```

/* Assume that the null input is 0.5V */
/* Assume that the requirement for the LSB is 50 $\mu$ V */
    FS = 65528 * 50e-6;          /*3.2764V */
    CNT1 = 0.5 / 50e-6;         /* 1000 */
    CNT2 = 0.9 X FS / 50e-6;    /* 58981.5 */
/* So the null input is 0.5V and 90% of FS is 2.949V */

Set the input's offset register to zero
gain_result = 0h;          /* Working register for gain
                           calculation */
CLAMP = FFF8h;          /* This is the max ADC value*/
For n = 15 down to 0
begin
    gain_result = gain_result + 2n;
    Write gain_result to the input's
    gain register;
    Force the 90% FS input (2.949V);
    Meas2= ADC result from DS1870;
    If Meas2  $\geq$  CLAMP
    Then
    gain_result = gain_result - 2n;
    Else
    Force the null input (0.5V)
    Meas1 = ADC result from DS1870
    If [(Meas2-Meas1)>(CNT2-CNT1)]
    Then
    gain_result = gain_result - 2n;
end;

Write gain_result to the input's gain
register;

```

The gain register is now set and the resolution of the conversion matches the expected LSB. Customers

requiring non-zero null values (e.g., 0.5V) must next calibrate the input's offset. If the desired null value is 0V, leave the offset register programmed to 0000h and skip this step.

To calibrate the offset register, program the gain register with the gain_result value determined above. Next, force the null input voltage (0.5V for the example) and read the digital result from the part (Meas1). The offset value can be calculated using the following formula:

$$\text{Offset} = -1 \times \left(\frac{\text{Meas1}}{4} \right)$$

Temperature-Monitor Offset Calibration

The DS1870's temperature sensor comes precalibrated and requires no further adjustment by the customer for proper operation. However, it is possible for customers to characterize their system and add a fixed offset to the DS1870's temperature reading so it is reflective of another location's temperature. This is not required for biasing because the temperature offset can be accounted for by adjusting the data's location in the LUTs, but this feature is available for customers who see application benefits.

To change the temperature sensor's offset: write the temperature offset register to 0000h, measure the source reference temperature (T_{ref}), and read the temperature from the DS1870 (T_{DS1870}). Then, the following formula can be used to calculate the value for the temperature offset register.

$$\text{TempOffset} = (64 \times (-275 + T_{\text{ref}} - T_{\text{DS1870}})) \text{ XOR}_{\text{bitwise}} \text{BB40h}$$

Once the value is calculated, write it to the temperature offset register.

Power-Up and Low-Voltage Operation

During power-up, the device is inactive until V_{CC} exceeds the digital power-on-reset voltage (V_{POD}). At this voltage, the digital circuitry, which includes the I²C-compatible interface, becomes functional. However, EEPROM-backed registers/settings cannot be internally read (recalled) until V_{CC} exceeds the analog power-on reset (V_{POA}), at which time the remainder of the device becomes fully functional. Once V_{CC} exceeds V_{POA} , the Rdyb bit in byte 74h is timed to go from a 1 to a 0 and indicates when ADC conversions begin. If V_{CC} ever dips below V_{POA} , the Rdyb bit reads as a 1 again. Once a device exceeds V_{POA} and the EEPROM is recalled, the values remain active (recalled) until V_{CC} falls below V_{POD} .

LDMOS RF Power-Amplifier Bias Controller

As the device powers up, the V_{CC} LO alarm flag defaults to a 1 until the first V_{CC} ADC conversion occurs and sets or clears the flag accordingly. The FAULT output is active when $V_{CC} < V_{POA}$.

Memory Description

The DS1870 memory map is divided into six sections that include the lower memory (addresses 00h to 7Fh) and five memory tables (Figure 2). The memory tables are addressed by setting the table-select byte (7Fh) to the desired table number and accessing the upper memory locations (80h to FFh). The lower memory can be addressed at any time regardless of the state of the table-select byte. The lower memory and memory table 1 are used to configure the DS1870 and read the status of the monitors. The lower memory also contains the 32 bytes of user memory. Memory tables 2 and 3 contain the base potentiometer positions that are used for biasing based on the reading of the internal temperature sensor. Memory tables 4 and 5 contain the relative offsets that are added to the base number as a function of either the drain voltage or the individual drain current monitors. See the *Memory Map* for a complete listing of registers and the *Register Description* section for details about each register.

Password Memory Protection

The DS1870 contains a 2-byte password that allows all of its EE memory to be write protected until the proper password is entered into the password entry (PWE) word (address 78h). This allows factory calibration data for the bias settings, alarm thresholds, and all the other EEPROM information to be write protected. The password is set by writing to the Password register, which is the first two bytes of memory table 1.

The factory default value for the password is FFFFh, which is also the factory default value for PWE on power-up. This means that parts are unlocked at

power-up when they are first received by customers. The password should be programmed to a value other than FFFFh to ensure the calibration data is write protected. The PWE register always reads 0000h regardless of its programmed value.

EEPROM Write Disable

Memory locations 20h to 3Fh and Table 1 locations 80h to A7h are SRAM-shadowed EEPROM. By default ($\overline{SEE} = 0$) these locations act as ordinary EEPROM. By setting $\overline{SEE} = 1$, these locations begin to function like SRAM cells, which allow an infinite number of write cycles without concern of wearing out the EEPROM. This also eliminates the requirement for the EEPROM write time. Because changes made with $\overline{SEE} = 1$ do not affect the EEPROM, these changes are not retained through power cycles. The power-up value is the last value written with $\overline{SEE} = 0$. This function can be used to limit the number of EEPROM writes during calibration or to change the monitor thresholds periodically during normal operation without wearing out the EEPROM. The \overline{SEE} bit resides in memory table 1, byte AFh.

Memory Map

The upper part of the memory map is organized into 8-byte or 4-word (2-byte) rows. The beginning address of the row is shown in the left-most column of the map, and is equal to the byte 0 or word 0 memory address. The next byte (Byte 1) is located at the next highest memory address, and the next word (Word 1) is two memory addresses greater than the row's beginning address. The lower part of the memory map expands the bytes or the words to show the names of the bits within the byte/word, or their bit weights (2^X) for registers that contain numerical information. Numerical registers that contain an "S" in the most significant bit are showing sign extension for 2's complement numbers. Descriptions of each byte/bit follow in the *Register Description* section.

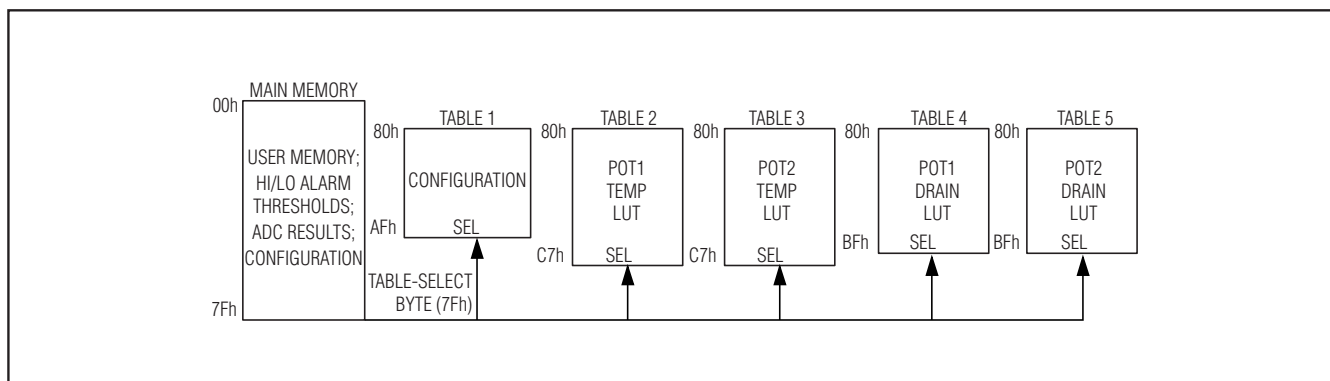

Figure 2. Memory Organization

LDMOS RF Power-Amplifier Bias Controller

DS1870

LOWER MEMORY																	
ROW (HEX)	ROW NAME	WORD 0				WORD 1				WORD 2				WORD 3			
		BYTE 0		BYTE 1		BYTE 2		BYTE 3		BYTE 4		BYTE 5		BYTE 6		BYTE 7	
00	User Row0	User EE	User EE	User EE	User EE	User EE	User EE	User EE	User EE	User EE	User EE	User EE	User EE	User EE	User EE	User EE	
08	User Row1	User EE	User EE	User EE	User EE	User EE	User EE	User EE	User EE	User EE	User EE	User EE	User EE	User EE	User EE	User EE	
10	User Row2	User EE	User EE	User EE	User EE	User EE	User EE	User EE	User EE	User EE	User EE	User EE	User EE	User EE	User EE	User EE	
18	User Row3	User EE	User EE	User EE	User EE	User EE	User EE	User EE	User EE	User EE	User EE	User EE	User EE	User EE	User EE	User EE	
20	Threshold0	Temp Hi Alarm				VCC Hi Alarm				VD Hi Alarm				ID1 Hi Alarm			
28	Threshold1	ID2 Hi Alarm				Reserved				Reserved				Reserved			
30	Threshold2	Temp Lo Alarm				VCC Lo Alarm				VD Lo Alarm				ID1 Lo Alarm			
38	Threshold3	ID2 Lo Alarm				Reserved				Reserved				Reserved			
40		Reserved	Reserved	Reserved	Reserved	Reserved	Reserved	Reserved	Reserved	Reserved	Reserved	Reserved	Reserved	Reserved	Reserved	Reserved	
48		Reserved	Reserved	Reserved	Reserved	Reserved	Reserved	Reserved	Reserved	Reserved	Reserved	Reserved	Reserved	Reserved	Reserved	Reserved	
50		Reserved	Reserved	Reserved	Reserved	Reserved	Reserved	Reserved	Reserved	Reserved	Reserved	Reserved	Reserved	Reserved	Reserved	Reserved	
58		Reserved	Reserved	Reserved	Reserved	Reserved	Reserved	Reserved	Reserved	Reserved	Reserved	Reserved	Reserved	Reserved	Reserved	Reserved	
60	A2D Value0	Temp Value				VCC Value				VD Value				ID1 Value			
68	A2D Value1	ID2 Value				Reserved				Reserved				Reserved			
70	Status	Hi Alarm	Lo Alarm	Reserved	Reserved	Reserved	Reserved	I/O Status	A2D Status	Reserved	Reserved	Reserved	Reserved	Reserved	Reserved	Reserved	
78	Table Select	PWE				Reserved	Reserved	Reserved	Reserved	Reserved	Reserved	Reserved	Reserved	Reserved	Reserved	Reserved	Tbl Sel
EXPANDED BYTES																	
BYTE (HEX)	BYTE NAME	BIT 7		BIT 6		BIT 5		BIT 4		BIT 3		BIT 2		BIT 1		BIT 0	
		BIT15	BIT14	BIT13	BIT12	BIT11	BIT10	BIT9	BIT8	BIT7	BIT6	BIT5	BIT4	BIT3	BIT2	BIT1	BIT0
00-1F	User EE	EE		EE		EE		EE		EE		EE		EE		EE	
20	Temp Hi Alrm	S	2 ⁶	2 ⁵	2 ⁴	2 ³	2 ²	2 ¹	2 ⁰	2 ¹	2 ²	2 ³	2 ⁴	2 ⁵	2 ⁶	2 ⁷	2 ⁸
22	VCC Hi Alrm	2 ¹⁵	2 ¹⁴	2 ¹³	2 ¹²	2 ¹¹	2 ¹⁰	2 ⁹	2 ⁸	2 ⁷	2 ⁶	2 ⁵	2 ⁴	2 ³	2 ²	2 ¹	2 ⁰
24	VD Hi Alrm	2 ¹⁵	2 ¹⁴	2 ¹³	2 ¹²	2 ¹¹	2 ¹⁰	2 ⁹	2 ⁸	2 ⁷	2 ⁶	2 ⁵	2 ⁴	2 ³	2 ²	2 ¹	2 ⁰
26	ID1 Hi Alrm	2 ¹⁵	2 ¹⁴	2 ¹³	2 ¹²	2 ¹¹	2 ¹⁰	2 ⁹	2 ⁸	2 ⁷	2 ⁶	2 ⁵	2 ⁴	2 ³	2 ²	2 ¹	2 ⁰
28	ID2 Hi Alrm	2 ¹⁵	2 ¹⁴	2 ¹³	2 ¹²	2 ¹¹	2 ¹⁰	2 ⁹	2 ⁸	2 ⁷	2 ⁶	2 ⁵	2 ⁴	2 ³	2 ²	2 ¹	2 ⁰
30	Temp Lo Alrm	S	2 ⁶	2 ⁵	2 ⁴	2 ³	2 ²	2 ¹	2 ⁰	2 ¹	2 ²	2 ³	2 ⁴	2 ⁵	2 ⁶	2 ⁷	2 ⁸
32	VCC Lo Alrm	2 ¹⁵	2 ¹⁴	2 ¹³	2 ¹²	2 ¹¹	2 ¹⁰	2 ⁹	2 ⁸	2 ⁷	2 ⁶	2 ⁵	2 ⁴	2 ³	2 ²	2 ¹	2 ⁰
34	VD Lo Alrm	2 ¹⁵	2 ¹⁴	2 ¹³	2 ¹²	2 ¹¹	2 ¹⁰	2 ⁹	2 ⁸	2 ⁷	2 ⁶	2 ⁵	2 ⁴	2 ³	2 ²	2 ¹	2 ⁰
36	ID1 Lo Alrm	2 ¹⁵	2 ¹⁴	2 ¹³	2 ¹²	2 ¹¹	2 ¹⁰	2 ⁹	2 ⁸	2 ⁷	2 ⁶	2 ⁵	2 ⁴	2 ³	2 ²	2 ¹	2 ⁰
38	ID2 Lo Alrm	2 ¹⁵	2 ¹⁴	2 ¹³	2 ¹²	2 ¹¹	2 ¹⁰	2 ⁹	2 ⁸	2 ⁷	2 ⁶	2 ⁵	2 ⁴	2 ³	2 ²	2 ¹	2 ⁰
60	Temp Value	S	2 ⁶	2 ⁵	2 ⁴	2 ³	2 ²	2 ¹	2 ⁰	2 ¹	2 ²	2 ³	2 ⁴	2 ⁵	2 ⁶	2 ⁷	2 ⁸
62	VCC Value	2 ¹⁵	2 ¹⁴	2 ¹³	2 ¹²	2 ¹¹	2 ¹⁰	2 ⁹	2 ⁸	2 ⁷	2 ⁶	2 ⁵	2 ⁴	2 ³	2 ²	2 ¹	2 ⁰
64	VD Value	2 ¹⁵	2 ¹⁴	2 ¹³	2 ¹²	2 ¹¹	2 ¹⁰	2 ⁹	2 ⁸	2 ⁷	2 ⁶	2 ⁵	2 ⁴	2 ³	2 ²	2 ¹	2 ⁰
66	ID1 Value	2 ¹⁵	2 ¹⁴	2 ¹³	2 ¹²	2 ¹¹	2 ¹⁰	2 ⁹	2 ⁸	2 ⁷	2 ⁶	2 ⁵	2 ⁴	2 ³	2 ²	2 ¹	2 ⁰
68	ID2 Value	2 ¹⁵	2 ¹⁴	2 ¹³	2 ¹²	2 ¹¹	2 ¹⁰	2 ⁹	2 ⁸	2 ⁷	2 ⁶	2 ⁵	2 ⁴	2 ³	2 ²	2 ¹	2 ⁰
70	Hi Alarm	Temp Hi		VCC Hi		VD Hi		ID1 Hi		ID2 Hi		Reserved		Reserved		Reserved	
71	Lo Alarm	Temp Lo		VCC Lo		VD Lo		ID1 Lo		ID2 Lo		Reserved		Reserved		Reserved	
74	I/O Status	Reserved		Reserved		Reserved		Reserved		Fault		Mint		Reserved		Rdyb	
75	A2D Status	Temp Rdy		VCC Rdy		VD Rdy		ID1 Rdy		ID2 Rdy		Reserved		Reserved		Reserved	
78	PWE	2 ¹⁵	2 ¹⁴	2 ¹³	2 ¹²	2 ¹¹	2 ¹⁰	2 ⁹	2 ⁸	2 ⁷	2 ⁶	2 ⁵	2 ⁴	2 ³	2 ²	2 ¹	2 ⁰
7F	Tbl Sel	2 ⁷		2 ⁶		2 ⁵		2 ⁴		2 ³		2 ²		2 ¹		2 ⁰	

LDMOS RF Power-Amplifier Bias Controller

TABLE 1 (CONFIGURATION)

ROW (HEX)	ROW NAME	WORD 0		WORD 1		WORD 2		WORD 3									
		BYTE 0	BYTE 1	BYTE 2	BYTE 3	BYTE 4	BYTE 5	BYTE 6	BYTE 7								
80	Config	Password					LUT Sel	Fault Ena	<i>Reserved</i>								
88	Scale ₀	<i>Reserved</i>		Vcc Scale		VD Scale		ID1 Scale									
90	Scale ₁	ID2 Scale		<i>Reserved</i>		<i>Reserved</i>		<i>Reserved</i>									
98	Offset ₀	<i>Reserved</i>		Vcc Offset		VD Offset		ID1 offset									
A0	Offset ₁	ID2 Offset		<i>Reserved</i>		<i>Reserved</i>		Temp Offset									
A8	LUT Index	T Index	O1 Index	O2 Index	POT1 base	POT1 off	POT2 base	POT2 off	Man Dac								
EXPANDED BYTES																	
BYTE (HEX)	BYTE NAME	BIT 7		BIT 6		BIT 5		BIT 4		BIT 3		BIT 2		BIT 1		BIT 0	
		BIT ₁₅	BIT ₁₄	BIT ₁₃	BIT ₁₂	BIT ₁₁	BIT ₁₀	BIT ₉	BIT ₈	BIT ₇	BIT ₆	BIT ₅	BIT ₄	BIT ₃	BIT ₂	BIT ₁	BIT ₀
80	Password	2 ¹⁵	2 ¹⁴	2 ¹³	2 ¹²	2 ¹¹	2 ¹⁰	2 ⁹	2 ⁸	2 ⁷	2 ⁶	2 ⁵	2 ⁴	2 ³	2 ²	2 ¹	2 ⁰
85	LUT Sel	<i>Reserved</i>	<i>Reserved</i>	<i>Reserved</i>	<i>Reserved</i>	<i>Reserved</i>	<i>Reserved</i>	<i>Reserved</i>	<i>Reserved</i>	<i>Reserved</i>	<i>Reserved</i>	<i>Reserved</i>	<i>Reserved</i>	VD2	<i>Reserved</i>	VD1	<i>Reserved</i>
86	Fault Ena	Temp Ena	Vcc Ena	VD Ena	ID1 Ena	ID2 Ena	<i>Reserved</i>	<i>Reserved</i>	<i>Reserved</i>	<i>Reserved</i>	<i>Reserved</i>	<i>Reserved</i>	<i>Reserved</i>	<i>Reserved</i>	<i>Reserved</i>	<i>Reserved</i>	<i>Reserved</i>
8A	Vcc	2 ¹⁵	2 ¹⁴	2 ¹³	2 ¹²	2 ¹¹	2 ¹⁰	2 ⁹	2 ⁸	2 ⁷	2 ⁶	2 ⁵	2 ⁴	2 ³	2 ²	2 ¹	2 ⁰
8C	VD Scale	2 ¹⁵	2 ¹⁴	2 ¹³	2 ¹²	2 ¹¹	2 ¹⁰	2 ⁹	2 ⁸	2 ⁷	2 ⁶	2 ⁵	2 ⁴	2 ³	2 ²	2 ¹	2 ⁰
8E	ID1 Scale	2 ¹⁵	2 ¹⁴	2 ¹³	2 ¹²	2 ¹¹	2 ¹⁰	2 ⁹	2 ⁸	2 ⁷	2 ⁶	2 ⁵	2 ⁴	2 ³	2 ²	2 ¹	2 ⁰
90	ID2 Scale	2 ¹⁵	2 ¹⁴	2 ¹³	2 ¹²	2 ¹¹	2 ¹⁰	2 ⁹	2 ⁸	2 ⁷	2 ⁶	2 ⁵	2 ⁴	2 ³	2 ²	2 ¹	2 ⁰
9A	Vcc Offset	S	S	2 ¹⁵	2 ¹⁴	2 ¹³	2 ¹²	2 ¹¹	2 ¹⁰	2 ⁹	2 ⁸	2 ⁷	2 ⁶	2 ⁵	2 ⁴	2 ³	2 ²
9C	VD Offset	S	S	2 ¹⁵	2 ¹⁴	2 ¹³	2 ¹²	2 ¹¹	2 ¹⁰	2 ⁹	2 ⁸	2 ⁷	2 ⁶	2 ⁵	2 ⁴	2 ³	2 ²
9E	ID1	S	S	2 ¹⁵	2 ¹⁴	2 ¹³	2 ¹²	2 ¹¹	2 ¹⁰	2 ⁹	2 ⁸	2 ⁷	2 ⁶	2 ⁵	2 ⁴	2 ³	2 ²
A0	ID2	S	S	2 ¹⁵	2 ¹⁴	2 ¹³	2 ¹²	2 ¹¹	2 ¹⁰	2 ⁹	2 ⁸	2 ⁷	2 ⁶	2 ⁵	2 ⁴	2 ³	2 ²
A6	Temp Offset	S	2 ⁸	2 ⁷	2 ⁶	2 ⁵	2 ⁴	2 ³	2 ²	2 ¹	2 ⁰	2 ⁻¹	2 ⁻²	2 ⁻³	2 ⁻⁴	2 ⁻⁵	2 ⁻⁶
A8	T Index	2 ⁷		2 ⁶		2 ⁵		2 ⁴		2 ³		2 ²		2 ¹		2 ⁰	
A9	O1 Index	2 ⁷		2 ⁶		2 ⁵		2 ⁴		2 ³		2 ²		2 ¹		2 ⁰	
AA	O2 Index	2 ⁷		2 ⁶		2 ⁵		2 ⁴		2 ³		2 ²		2 ¹		2 ⁰	
AB	POT1 base	2 ⁷		2 ⁶		2 ⁵		2 ⁴		2 ³		2 ²		2 ¹		2 ⁰	
AC	POT1 off	S		2 ⁶		2 ⁵		2 ⁴		2 ³		2 ²		2 ¹		2 ⁰	
AD	POT2 base	2 ⁷		2 ⁶		2 ⁵		2 ⁴		2 ³		2 ²		2 ¹		2 ⁰	
AE	POT2 off	S		2 ⁶		2 ⁵		2 ⁴		2 ³		2 ²		2 ¹		2 ⁰	
AF	Man DAC	<i>Reserved</i>	<i>Reserved</i>	<i>Reserved</i>	<i>Reserved</i>	<i>Reserved</i>	<i>Reserved</i>	<i>Reserved</i>	<i>Reserved</i>	<i>Reserved</i>	<i>Reserved</i>	<i>Reserved</i>	SEE	B/O_en	index_en		

LDMOS RF Power-Amplifier Bias Controller

DS1870

TABLE 2 (POT1 TEMP LUT)									
ROW (HEX)	ROW NAME	WORD 0		WORD 1		WORD 2		WORD 3	
		BYTE 0	BYTE 1	BYTE 2	BYTE 3	BYTE 4	BYTE 5	BYTE 6	BYTE 7
80	LUT	POT1	POT1	POT1	POT1	POT1	POT1	POT1	POT1
88	LUT	POT1	POT1	POT1	POT1	POT1	POT1	POT1	POT1
90	LUT	POT1	POT1	POT1	POT1	POT1	POT1	POT1	POT1
98	LUT	POT1	POT1	POT1	POT1	POT1	POT1	POT1	POT1
A0	LUT	POT1	POT1	POT1	POT1	POT1	POT1	POT1	POT1
A8	LUT	POT1	POT1	POT1	POT1	POT1	POT1	POT1	POT1
B0	LUT	POT1	POT1	POT1	POT1	POT1	POT1	POT1	POT1
B8	LUT	POT1	POT1	POT1	POT1	POT1	POT1	POT1	POT1
C0	LUT	POT1	POT1	POT1	POT1	POT1	POT1	POT1	POT1
C8		<i>Reserved</i>	<i>Reserved</i>	<i>Reserved</i>	<i>Reserved</i>	<i>Reserved</i>	<i>Reserved</i>	<i>Reserved</i>	<i>Reserved</i>
D0		<i>Reserved</i>	<i>Reserved</i>	<i>Reserved</i>	<i>Reserved</i>	<i>Reserved</i>	<i>Reserved</i>	<i>Reserved</i>	<i>Reserved</i>
D8		<i>Reserved</i>	<i>Reserved</i>	<i>Reserved</i>	<i>Reserved</i>	<i>Reserved</i>	<i>Reserved</i>	<i>Reserved</i>	<i>Reserved</i>
E0		<i>Reserved</i>	<i>Reserved</i>	<i>Reserved</i>	<i>Reserved</i>	<i>Reserved</i>	<i>Reserved</i>	<i>Reserved</i>	<i>Reserved</i>
E8		<i>Reserved</i>	<i>Reserved</i>	<i>Reserved</i>	<i>Reserved</i>	<i>Reserved</i>	<i>Reserved</i>	<i>Reserved</i>	<i>Reserved</i>
F0		<i>Reserved</i>	<i>Reserved</i>	<i>Reserved</i>	<i>Reserved</i>	<i>Reserved</i>	<i>Reserved</i>	<i>Reserved</i>	<i>Reserved</i>
F8		<i>Reserved</i>	<i>Reserved</i>	<i>Reserved</i>	<i>Reserved</i>	<i>Reserved</i>	<i>Reserved</i>	<i>Reserved</i>	<i>Reserved</i>
EXPANDED BYTES									
BYTE (HEX)	BYTE NAME	BIT 7	BIT 6	BIT 5	BIT 4	BIT 3	BIT 2	BIT 1	BIT 0
80-C7	POT1	2 ⁷	2 ⁶	2 ⁵	2 ⁴	2 ³	2 ²	2 ¹	2 ⁰

LDMOS RF Power-Amplifier Bias Controller

TABLE 3 (POT2 TEMP LUT)									
ROW (HEX)	ROW NAME	WORD 0		WORD 1		WORD 2		WORD 3	
		BYTE 0	BYTE 1	BYTE 2	BYTE 3	BYTE 4	BYTE 5	BYTE 6	BYTE 7
80	LUT	POT2	POT2	POT2	POT2	POT2	POT2	POT2	POT2
88	LUT	POT2	POT2	POT2	POT2	POT2	POT2	POT2	POT2
90	LUT	POT2	POT2	POT2	POT2	POT2	POT2	POT2	POT2
98	LUT	POT2	POT2	POT2	POT2	POT2	POT2	POT2	POT2
A0	LUT	POT2	POT2	POT2	POT2	POT2	POT2	POT2	POT2
A8	LUT	POT2	POT2	POT2	POT2	POT2	POT2	POT2	POT2
B0	LUT	POT2	POT2	POT2	POT2	POT2	POT2	POT2	POT2
B8	LUT	POT2	POT2	POT2	POT2	POT2	POT2	POT2	POT2
C0	LUT	POT2	POT2	POT2	POT2	POT2	POT2	POT2	POT2
C8		<i>Reserved</i>	<i>Reserved</i>	<i>Reserved</i>	<i>Reserved</i>	<i>Reserved</i>	<i>Reserved</i>	<i>Reserved</i>	<i>Reserved</i>
D0		<i>Reserved</i>	<i>Reserved</i>	<i>Reserved</i>	<i>Reserved</i>	<i>Reserved</i>	<i>Reserved</i>	<i>Reserved</i>	<i>Reserved</i>
D8		<i>Reserved</i>	<i>Reserved</i>	<i>Reserved</i>	<i>Reserved</i>	<i>Reserved</i>	<i>Reserved</i>	<i>Reserved</i>	<i>Reserved</i>
E0		<i>Reserved</i>	<i>Reserved</i>	<i>Reserved</i>	<i>Reserved</i>	<i>Reserved</i>	<i>Reserved</i>	<i>Reserved</i>	<i>Reserved</i>
E8		<i>Reserved</i>	<i>Reserved</i>	<i>Reserved</i>	<i>Reserved</i>	<i>Reserved</i>	<i>Reserved</i>	<i>Reserved</i>	<i>Reserved</i>
F0		<i>Reserved</i>	<i>Reserved</i>	<i>Reserved</i>	<i>Reserved</i>	<i>Reserved</i>	<i>Reserved</i>	<i>Reserved</i>	<i>Reserved</i>
F8		<i>Reserved</i>	<i>Reserved</i>	<i>Reserved</i>	<i>Reserved</i>	<i>Reserved</i>	<i>Reserved</i>	<i>Reserved</i>	<i>Reserved</i>
EXPANDED BYTES									
BYTE (HEX)	BYTE NAME	BIT 7	BIT 6	BIT 5	BIT 4	BIT 3	BIT 2	BIT 1	BIT 0
80-C7	POT2	2 ⁷	2 ⁶	2 ⁵	2 ⁴	2 ³	2 ²	2 ¹	2 ⁰

LDMOS RF Power-Amplifier Bias Controller

DS1870

TABLE 4 (POT1 DRAIN LUT)									
ROW (HEX)	ROW NAME	WORD 0		WORD 1		WORD 2		WORD 3	
		BYTE 0	BYTE 1	BYTE 2	BYTE 3	BYTE 4	BYTE 5	BYTE 6	BYTE 7
80	LUT	POT1 Off	POT1 Off	POT1 Off	POT1 Off	POT1 Off	POT1 Off	POT1 Off	POT1 Off
88	LUT	POT1 Off	POT1 Off	POT1 Off	POT1 Off	POT1 Off	POT1 Off	POT1 Off	POT1 Off
90	LUT	POT1 Off	POT1 Off	POT1 Off	POT1 Off	POT1 Off	POT1 Off	POT1 Off	POT1 Off
98	LUT	POT1 Off	POT1 Off	POT1 Off	POT1 Off	POT1 Off	POT1 Off	POT1 Off	POT1 Off
A0	LUT	POT1 Off	POT1 Off	POT1 Off	POT1 Off	POT1 Off	POT1 Off	POT1 Off	POT1 Off
A8	LUT	POT1 Off	POT1 Off	POT1 Off	POT1 Off	POT1 Off	POT1 Off	POT1 Off	POT1 Off
B0	LUT	POT1 Off	POT1 Off	POT1 Off	POT1 Off	POT1 Off	POT1 Off	POT1 Off	POT1 Off
B8	LUT	POT1 Off	POT1 Off	POT1 Off	POT1 Off	POT1 Off	POT1 Off	POT1 Off	POT1 Off
EXPANDED BYTES									
BYTE (HEX)	BYTE NAME	BIT 7	BIT 6	BIT 5	BIT 4	BIT 3	BIT 2	BIT 1	BIT 0
80-BF	POT1 Off	S	2 ⁶	2 ⁵	2 ⁴	2 ³	2 ²	2 ¹	2 ⁰

TABLE 5 (POT2 DRAIN LUT)									
ROW (HEX)	ROW NAME	WORD 0		WORD 1		WORD 2		WORD 3	
		BYTE 0	BYTE 1	BYTE 2	BYTE 3	BYTE 4	BYTE 5	BYTE 6	BYTE 7
80	LUT	POT2 Off	POT2 Off	POT2 Off	POT2 Off	POT2 Off	POT2 Off	POT2 Off	POT2 Off
88	LUT	POT2 Off	POT2 Off	POT2 Off	POT2 Off	POT2 Off	POT2 Off	POT2 Off	POT2 Off
90	LUT	POT2 Off	POT2 Off	POT2 Off	POT2 Off	POT2 Off	POT2 Off	POT2 Off	POT2 Off
98	LUT	POT2 Off	POT2 Off	POT2 Off	POT2 Off	POT2 Off	POT2 Off	POT2 Off	POT2 Off
A0	LUT	POT2 Off	POT2 Off	POT2 Off	POT2 Off	POT2 Off	POT2 Off	POT2 Off	POT2 Off
A8	LUT	POT2 Off	POT2 Off	POT2 Off	POT2 Off	POT2 Off	POT2 Off	POT2 Off	POT2 Off
B0	LUT	POT2 Off	POT2 Off	POT2 Off	POT2 Off	POT2 Off	POT2 Off	POT2 Off	POT2 Off
B8	LUT	POT2 Off	POT2 Off	POT2 Off	POT2 Off	POT2 Off	POT2 Off	POT2 Off	POT2 Off
EXPANDED BYTES									
BYTE (HEX)	BYTE NAME	BIT 7	BIT 6	BIT 5	BIT 4	BIT 3	BIT 2	BIT 1	BIT 0
80-BF	POT2 Off	S	2 ⁶	2 ⁵	2 ⁴	2 ³	2 ²	2 ¹	2 ⁰

LDMOS RF Power-Amplifier Bias Controller

Register Description

The register descriptions are organized by the register's row address starting with the lower memory, then proceeding through each lookup table in order. The format of the register description is shown below.

TABLE NAME

Name of Row

Name of Byte <Access><Volatility><Power-On/
Factor Default Values> Description
of the byte's function

a) *bit X* *bit X description*

b) *bit Y* *bit Y description*

The **Access** value following each byte's name defines the read/write access for the register. Possible values are read-only (R), write-only (W), and read-write (R/W). The **Volatility** parameter defines if the memory is volatile (V) or nonvolatile (NV). Some registers correspond to values measured or detected by the DS1870. These parameters are read-only and listed as NA since their values are indeterminate. **Power-On** values are the default states of the volatile register, and the **Factory Default** values are the values the EEPROM memory is programmed to by the factory before they are shipped from Dallas Semiconductor.

LOWER MEMORY

User Row

User EE <R/W><NV><00h> NV EEPROM user memory.

Threshold₀

Temp Hi Alarm <R/W><NV><0000h> Temperature measurements above this 2's complement threshold set its corresponding alarm bit. Measurements below this threshold clear the alarm bit.

Vcc Hi Alarm <R/W><NV><0000h> Voltage measurements of the V_{CC} input above this unsigned threshold set its corresponding alarm bit. Measurements below this threshold clear the alarm bit.

VD Hi Alarm <R/W><NV><0000h> Voltage measurements of the V_D input above this unsigned threshold set its corresponding alarm bit. Measurements below this threshold clear the alarm bit.

ID1 Hi Alarm <R/W><NV><0000h> Voltage measurements of the I_{D1} input above this unsigned threshold set its corresponding alarm bit. Measurements below this threshold clear the alarm bit.

Threshold₁

ID2 Hi Alarm <R/W><NV><0000h> Voltage measurements of the I_{D2} input above this unsigned threshold set its corresponding alarm bit. Measurements below this threshold clear the alarm bit.

Threshold₂

Temp Lo Alarm <R/W><NV><0000h> Temperature measurements below this 2's complement threshold set its corresponding alarm bit. Measurements above this threshold clear the alarm bit.

Vcc Lo Alarm <R/W><NV><0000h> Voltage measurements of the V_{CC} below above this unsigned threshold set its corresponding alarm bit. Measurements above this threshold clear the alarm bit.

VD Lo Alarm <R/W><NV><0000h> Voltage measurements of the V_D input below this unsigned threshold set its corresponding alarm bit. Measurements above this threshold clear the alarm bit.

ID1 Lo Alarm <R/W><NV><0000h> Voltage measurements of the I_{D1} input below this unsigned threshold set its corresponding alarm bit. Measurements above this threshold clear the alarm bit.

Threshold₃

ID1 Lo Alarm <R/W><NV><0000h> Voltage measurements of the I_{D2} input below this unsigned threshold set its corresponding alarm bit. Measurements above this threshold clear the alarm bit.

LDMOS RF Power-Amplifier Bias Controller

A2D Value₀

- Temp Value* <R><NA><0000h> The signed 2's complement direct-to-temperature measurement.
- Vcc Value* <R><NA><0000h> Unsigned V_{CC} voltage measurement.
- VD Value* <R><NA><0000h> Unsigned V_D voltage measurement.
- ID1 Value* <R><NA><0000h> Unsigned I_{D1} voltage measurement.

A2D Value₁

- ID2 Value* <R><NA><0000h> Unsigned I_{D2} voltage measurement.

Status

- Hi Alarm* <R><NA><00h> High-Alarm Status bits.

- a) Temp Hi High-alarm status for temperature measurement.
- b) Vcc Hi High-alarm status for V_{CC} measurement.
- c) VD Hi High-alarm status for V_D measurement.
- d) ID1 Hi High-alarm status for I_{D1} measurement.
- e) ID2 HI High-alarm status for I_{D2} measurement.

- Lo Alarm* <R><NA><40h> Low-Alarm Status bits.

- a) Temp Lo Low-alarm status for temperature measurement.
- b) Vcc Lo Low-alarm status for V_{CC} measurement. This bit is set when the V_{CC} supply is below the POR trip-point value. It clears itself when a V_{CC} measurement is completed and the value is above the low threshold.
- c) VD Lo Low-alarm status for V_D measurement.
- d) ID1 Lo Low-alarm status for I_{D1} measurement.
- e) ID2 Lo Low-alarm status for I_{D2} measurement.

- I/O Status* <R><NA><see below> Status of the FAULT pin.

- a) Fault Logical value of the FAULT pin. Fault is logic HIGH during power-on.
- b) Mint Maskable Interrupt. FAULT is an open-drain output. In case FAULT was pulled low externally or was missing the external pullup resistor, this bit reflects the logical value the DS1870 is trying to output on the FAULT pin. If any 'Hi Alarm' or 'Lo Alarm' is active and its corresponding 'Fault Ena' bit is enabled, or 'RDBY' is a 1, then this bit is active high. Otherwise, this bit is a zero.
- c) Rdyb Ready Bar. When the supply is above the power-on-analog (V_{POA}) trip point, this bit is active low. Thus, this bit reads a logic 1 if the supply is below V_{POA} or too low to communicate over the I²C bus.

- A2D Status* <R/W><V><00h> Status of completed conversions. At power-on, these bits are cleared and are set as each conversion is completed. These bits can be cleared so that completion of new conversions may be verified.

- a) Temp Rdy Temperature conversion is ready.
- b) Vcc Rdy V_{CC} conversion is ready.
- c) VD Rdy V_D conversion is ready.
- d) ID1 Rdy I_{D1} conversion is ready.
- e) ID2 Rdy I_{D2} conversion is ready.

LDMOS RF Power-Amplifier Bias Controller

PWE

- PWE* <W><V><FFFFh> Password Entry. Until the correct password is written to this location, the only memory that can be written are addresses 78h to 7Fh. This includes the PWE and Table_Select locations. All memory is readable regardless of the PWE value.
- TBL Sel* <R/W><V><00h> Table Select. The DS1870 contains four tables (1 to 5). Writing a (1 to 5) value to this register grants access to the corresponding table.

TABLE 1 (CONFIGURATION)

Config

- Password* <R/W><NV><FFFFh> The PWE value is compared against the value written to this location. All EEPROM memory is write-protected when PWE does not match this register.
- LUT Sel* <R/W><NV><03h> Selects which inputs are used to control the lookup tables.
- a) *VD2* A one selects the V_D input to control the drain LUT indexing for POT2 (Table 5). A zero selects the I_{D2} input.
- b) *VD1* A one selects the V_D input to control the drain LUT indexing for POT1 (Table 4). A zero selects the I_{D1} input.
- Fault Ena* <R/W><NV><00h> Configures the maskable interrupt for the FAULT pin.
- a) *Temp Ena* Temperature measurements, outside the threshold limits, are enabled to create an active interrupt on the FAULT pin.
- b) *Vcc Ena* V_{CC} measurements, outside the threshold limits, are enabled to create an active interrupt on the FAULT pin.
- c) *VD Ena* V_D measurements, outside the threshold limits, are enabled to create an active interrupt on the FAULT pin.
- d) *ID1 Ena* I_{D1} measurements, outside the threshold limits, are enabled to create an active interrupt on the FAULT pin.
- e) *ID2 Ena* I_{D2} measurements, outside the threshold limits, are enabled to create an active interrupt on the FAULT pin.

Scale₀

- Vcc Scale* <R/W><NV><XXXX> Controls the scaling or gain of the V_{CC} measurements. The V_{CC} gain is factory trimmed to 6.5535V FS.
- VD Scale* <R/W><NV><XXXX> Controls the scaling or gain of the V_D measurements. The V_D gain is factory trimmed to 2.500V FS.
- ID1 Scale* <R/W><NV><XXXX> Controls the scaling or gain of the I_{D1} measurements. The I_{D1} gain is factory trimmed to 0.5V FS.

Scale₁

- ID2 Scale* <R/W><NV><XXXX> Controls the scaling or gain of the I_{D2} measurements. The I_{D2} gain is factory trimmed to 0.5V FS.

Offset₀

- Vcc Offset* <R/W><NV><0000h> Allows for offset control of V_{CC} measurement
- VD Offset* <R/W><NV><0000h> Allows for offset control of V_D measurement.
- ID1 Offset* <R/W><NV><0000h> Allows for offset control of I_{D1} measurement.

Offset₁

- ID2 Offset* <R/W><NV><0000h> Allows for offset control of I_{D2} measurement.
- Temp Offset* <R/W><NV><0000h> Allows for offset control of temperature measurement.

LUT Index

LDMOS RF Power-Amplifier Bias Controller

DS1870

<i>T Index</i>	<R><NA><00h> Holds the calculated index based on the temperature measurement. This index is used to address LUTs 2 and 3.
<i>O1 Index</i>	<R><NA><00h> Holds the calculated index based on the V_D or I_{D1} measurement (dependant on 'LUT Sel' byte). This index is used to address LUT 4.
<i>O2 Index</i>	<R><NA><00h> Holds the calculated index based on the V_D or I_{D2} measurement (dependant on 'LUT Sel' byte). This index is used to address LUT 5.
<i>POT1 base</i>	<R><NA><00h> The base value used for POT1 and recalled from Table 2 at the memory address found in 'T Index.' This register is updated at the end of the temperature conversion. POT1 is not updated with this value until the end of I_{D2} conversion to ensure that both the base and the offset are known for POT1 and POT2 and they are updated simultaneously.
<i>POT1 off</i>	<R><NA><00h> The offset value used for POT1 and recalled from Table 4 at the memory address found in 'O1 Index.' Depending on the value written to 'LUT Sel' byte, this register is updated at the end of the V_D or I_{D1} conversion. POT1 is not updated with this value until the end of I_{D2} conversion to ensure that both the base and the offset are known for POT1 and POT2 and they are updated simultaneously.
<i>POT2 base</i>	<R><NA><00h> The base value used for POT2 and recalled from Table 3 at the memory address found in 'T Index.' This register is updated at the end of the temperature conversion. POT2 is not updated with this value until the end of I_{D2} conversion to ensure that both the base and the offset are known for POT1 and POT2 and they are updated simultaneously.
<i>POT2 off</i>	<R><NA><00h> The Offset value used for POT2 and recalled from Table 5 at the memory address found in 'O2 Index.' Depending on the value written to 'LUT Sel' byte, this register is updated at the end of the V_D or I_{D2} conversion. POT2 is not updated with this value until the end of I_{D2} conversion to ensure that both the base and the offset are known for POT1 and POT2 and they are updated simultaneously.
<i>MAN Dac</i>	<R/W><NA><03h> Allows user to control either the LUT Index or the base and offset values used to calculate the potentiometer positions.
a) \overline{SEE}	Shadow EE bar. At power-on this bit is low, which enables EE writes to all shadowed EE locations. If written to a one, this bit allows for trimming and/or configuring the part without changing the NV-shadowed EE memory and not having to wait for the EE cycle time to complete. Writing this bit to a zero does not cause a write from the SRAM to copy into the EE. Shadow EE locations are addresses 20h to 3Fh and Table 180h to A7h.
b) B/O_en	At power-on this bit is high, which enables auto control of the LUT. If this bit is written to a zero, then the POT base and offset are writeable by the user and the LUT recalls are disabled. This allows the user to interactively test their modules by writing the base and/or offsets for the POTs. The POTs update with the new value at the end of the write cycle. Thus, all four registers ('POT1 Base,' 'POT1 Off,' 'POT2 Base,' and 'POT2 OFF') should be written in the same write cycle. The I ² C stop condition is the end of the write cycle.
c) Index_en	At power-on this bit is high, which enables auto control of the LUT. If this bit is cleared to a zero, then the three index values ('T index,' 'O1 Index,' and 'O2 Index') are writeable by the user and the updates of calculated indexes are disabled. This allows the user to interactively test their modules by controlling the indexing for the lookup tables. All three index values should be written in the same write cycle. The recalled values from the LUTs appear in the base and offset register after each corresponding conversion (just like it would happen in auto mode). To ensure the recalled base and offset values from the LUT are updated, the base and offset calculation will not update the potentiometers until the completion of the next temperature and I_{D2} conversion. Both pots update at the same time (just like it would happen in auto mode).

LDMOS RF Power-Amplifier Bias Controller

TABLE 2 (TEMP LUT FOR POT 1)

Bytes 80h–C7h

POT1 <R/W><NV><00h>The unsigned base value for POT1.

TABLE 3 (TEMP LUT FOR POT 2)

Bytes 80h–C7h

POT2 <R/W><NV><00h>The unsigned base value for POT2.

TABLE 4 (DRAIN LUT FOR POT 1)

Bytes 80h–B8h

POT1 Off <R/W><NV><00h>The signed 2's complement offset value for POT1.

TABLE 5 (DRAIN LUT FOR POT 2)

Bytes 80h–B8h

POT2 Off <R/W><NV><00h>The signed 2's complement offset value for POT2.

I²C Definitions

The following terminology is commonly used to describe I²C data transfers.

Master device: The master device controls the slave devices on the bus. The master device generates SCL clock pulses, and start and stop conditions.

Slave devices: Slave devices send and receive data at the master's request.

Bus idle or not busy: Time between stop and start conditions when both SDA and SCL are inactive and in their logic high states. When the bus is idle, it often initiates a low-power mode for slave devices.

Start condition: A start condition is generated by the master to initiate a new data transfer with a slave. Transitioning SDA from high to low while SCL remains high generates a start condition. See the timing diagram for applicable timing.

Stop condition: A stop condition is generated by the master to end a data transfer with a slave. Transitioning SDA from low to high while SCL remains high generates a stop condition. See the timing diagram for applicable timing.

Repeated start condition: The master can use a repeated start condition at the end of one data transfer to indicate that it will immediately initiate a new data transfer following the current one. Repeated starts are commonly used during read operations to identify a specific memory address to begin a data transfer. A repeated start condition is issued identically to a normal start condition. See the timing diagram for applicable timing.

Bit write: Transitions of SDA must occur during the low state of SCL. The data on SDA must remain valid and unchanged during the entire high pulse of SCL plus the

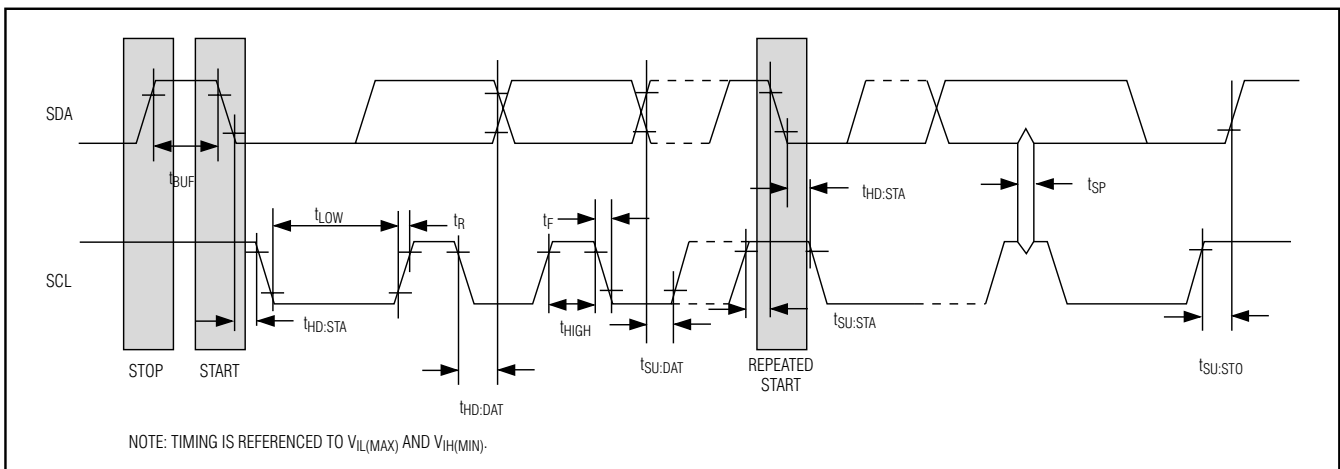

Figure 3. I²C Timing Diagram

LDMOS RF Power-Amplifier Bias Controller

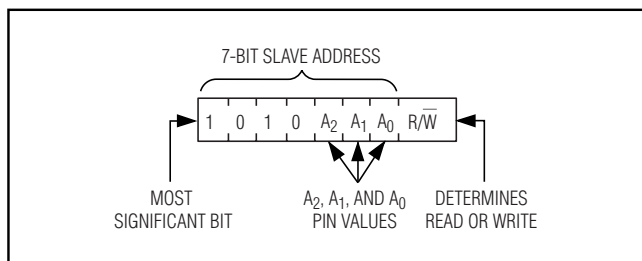

Figure 4. Slave Address Byte

setup and hold time requirements (Figure 3). Data is shifted into the device during the rising edge of the SCL.

Bit read: At the end a write operation, the master must release the SDA bus line for the proper amount of setup time (Figure 3) before the next rising edge of SCL during a bit read. The device shifts out each bit of data on SDA at the falling edge of the previous SCL pulse and the data bit is valid at the rising edge of the current SCL pulse. Remember that the master generates all SCL clock pulses, including when it is reading bits from the slave.

Acknowledgement (ACK and NACK): An acknowledgement (ACK) or not acknowledge (NACK) is always the 9th bit transmitted during a byte transfer. The device receiving data (the master during a read or the slave during a write operation) performs an ACK by transmitting a zero during the 9th bit. A device performs a NACK by transmitting a one during the 9th bit. Timing (Figure 3) for the ACK and NACK is identical to all other bit writes. An ACK is the acknowledgment that the device is properly receiving data. A NACK is used to terminate a read sequence or as an indication that the device is not receiving data.

Byte write: A byte write consists of 8 bits of information transferred from the master to the slave (most significant bit first) plus a 1-bit acknowledgement from the slave to the master. The 8 bits transmitted by the master are done according to the bit write definition and the acknowledgement is read using the bit read definition.

Byte read: A byte read is an 8-bit information transfer from the slave to the master plus a 1-bit ACK or NACK from the master to the slave. The 8 bits of information that are transferred (most significant bit first) from the slave to the master are read by the master using the bit read definition above, and the master transmits an ACK using the bit write definition to receive additional data bytes. The master must NACK the last byte read to terminate communication so the slave will return control of SDA to the master.

Slave address byte: Each slave on the I²C bus responds to a slave addressing byte sent immediately

following a start condition. The slave address byte (Figure 4) contains the slave address in the most significant 7 bits and the R/W bit in the least significant bit.

The DS1870's slave address is 1010A₂A₁A₀ (binary), where A₂, A₁, and A₀ are the values of the address pins. The address pins allow the device to respond to one of eight possible slave addresses. By writing the correct slave address with R/W = 0, the master indicates it will write data to the slave. If R/W = 1, the master will read data from the slave. If an incorrect slave address is written, the DS1870 assumes the master is communicating with another I²C device and ignores the communications until the next start condition is sent.

Memory address: During an I²C write operation, the master must transmit a memory address to identify the memory location where the slave is to store the data. The memory address is always the second byte transmitted during a write operation following the slave address byte.

I²C Communication

Writing a single byte to a slave: The master must generate a start condition, write the slave address byte (R/W = 0), write the memory address, write the byte of data, and generate a stop condition. Remember the master must read the slave's acknowledgement during all byte write operations.

Writing multiple bytes to a slave: To write multiple bytes to a slave, the master generates a start condition, writes the slave address byte (R/W = 0), writes the memory address, writes up to 8 data bytes, and generates a stop condition.

The DS1870 writes 1 to 8 bytes (1 page or row) with a single write transaction. This is internally controlled by an address counter that allows data to be written to consecutive addresses without transmitting a memory address before each data byte is sent. The address counter limits the write to one 8-byte page (one row of the memory map). Attempts to write to additional pages of memory without sending a stop condition between pages results in the address counter wrapping around to the beginning of the present row.

Example: A 3-byte write starts at address 06h and writes three data bytes (11h, 22h, and 33h) to three "consecutive" addresses. The result is that addresses 06h and 07h would contain 11h and 22h, respectively, and the third data byte, 33h, would be written to address 00h.

To prevent address wrapping from occurring, the master must send a stop condition at the end of the page, then wait for the bus-free or EEPROM-write time to elapse. Then the master can generate a new start con-

LDMOS RF Power-Amplifier Bias Controller

dition, and write the slave address byte ($R/\bar{W} = 0$) and the first memory address of the next memory row before continuing to write data.

Acknowledge polling: Any time an EEPROM page is written, the DS1870 requires the EEPROM write time (t_w) after the stop condition to write the contents of the page to EEPROM. During the EEPROM write time, the DS1870 will not acknowledge its slave address because it is busy. It is possible to take advantage of that phenomenon by repeatedly addressing the DS1870, which allows the next page to be written as soon as the DS1870 is ready to receive the data. The alternative to acknowledge polling is to wait for maximum period of t_w to elapse before attempting to write again to the DS1870.

EEPROM write cycles: When EEPROM writes occur, the DS1870 writes the whole EEPROM memory page, even if only a single byte on the page was modified. Writes that do not modify all 8 bytes on the page are allowed and do not corrupt the remaining bytes of memory on the same page. Because the whole page is written, bytes on the page that were not modified during the transaction are still subject to a write cycle. This can result in a whole page being worn out over time by writing a single byte repeatedly. Writing a page one

byte at a time wears the EEPROM out eight times faster than writing the entire page at once. The DS1870's EEPROM write cycles are specified in the *Nonvolatile Memory Characteristics* table. The specification shown is at the worst-case temperature. It can handle approximately 10x that many writes at room temperature. Writing to SRAM-shadowed EEPROM memory with $\overline{SEE} = 1$ does not count as an EEPROM write cycle when evaluating the EEPROM's estimated lifetime.

Reading a single byte from a slave: Unlike the write operation that uses the memory address byte to define where the data is to be written, the read operation occurs at the present value of the memory address counter. To read a single byte from the slave, the master generates a start condition, writes the slave address byte with $R/\bar{W} = 1$, reads the data byte with a NACK to indicate the end of the transfer, and generates a stop condition.

Manipulating the address counter for reads: A dummy write cycle can be used to force the address counter to a particular value. To do this, the master generates a start condition, writes the slave address byte ($R/\bar{W} = 0$), writes the memory address where it desires to read, generates a repeated start condition, writes the slave address byte ($R/\bar{W} = 1$), reads data with ACK or NACK as applicable, and generates a stop condition.

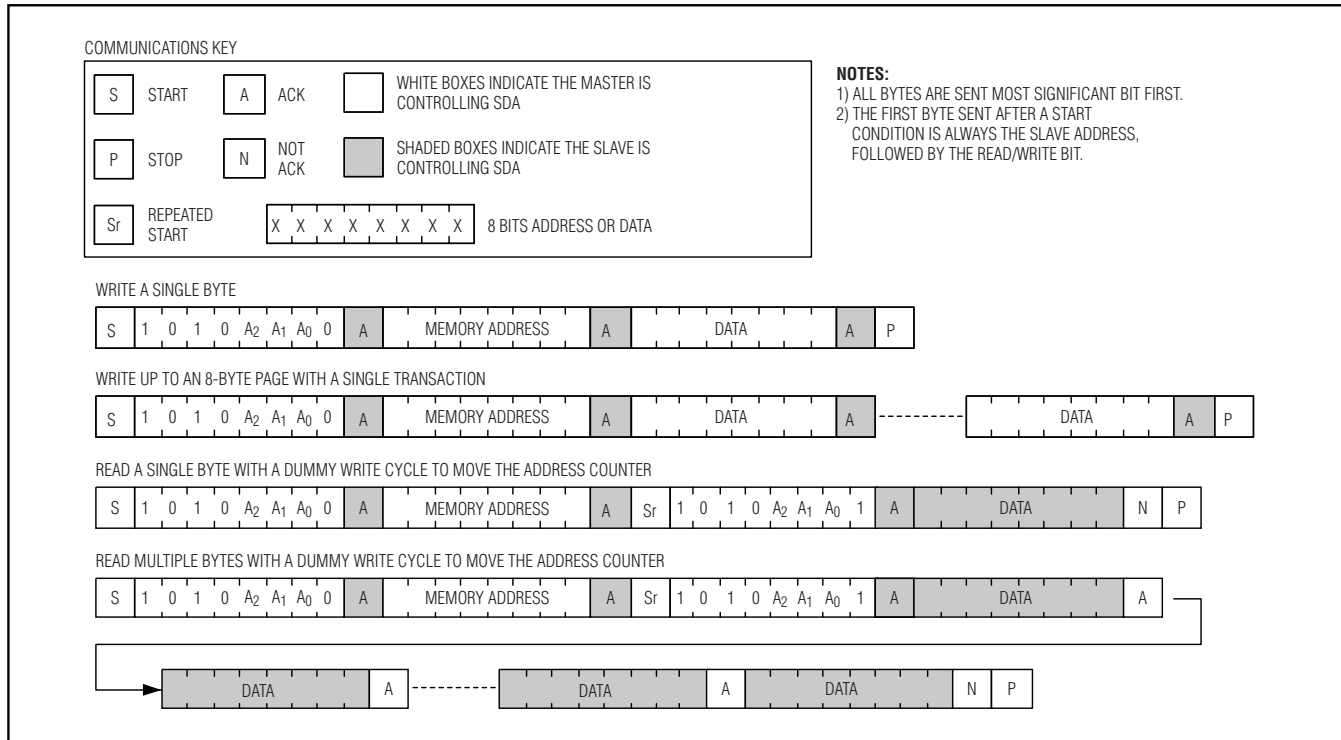
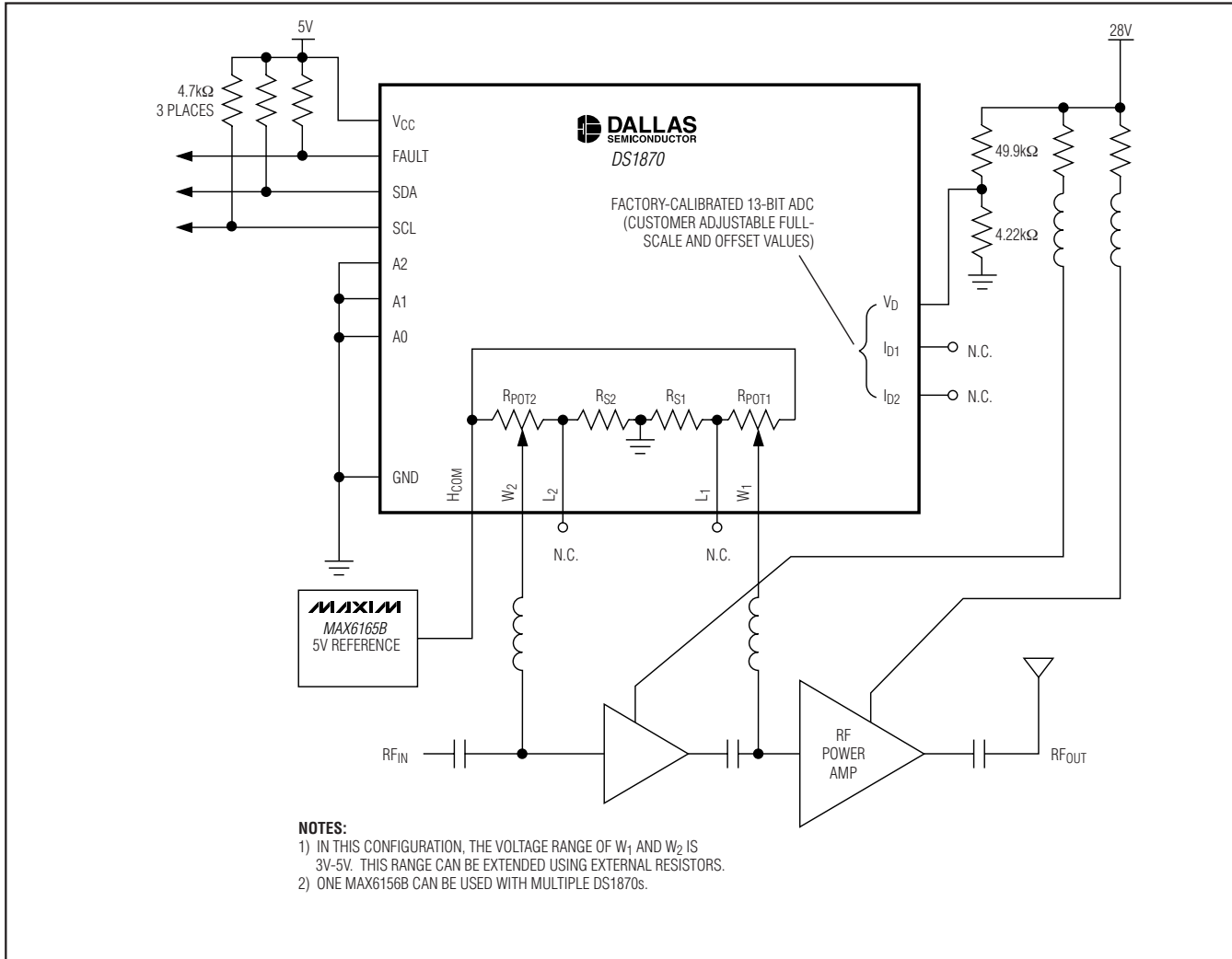

Figure 5. I²C Communications Examples

LDMOS RF Power-Amplifier Bias Controller

Typical Operating Circuit

DS1870



See Figure 5 for a read example using the repeated start condition to specify the starting memory location.

Reading multiple bytes from a slave: The read operation can be used to read multiple bytes with a single transfer. When reading bytes from the slave, the master simply ACKs the data byte if it desires to read another byte before terminating the transaction. After the master reads the last byte it NACKs to indicate the end of the transfer and generates a stop condition. This can be done with or without modifying the address counter's location before the read cycle. The DS1870's address counter does not wrap on page boundaries during read

operations, but the counter will roll from its upper most memory address FFh to 00h if the last memory location is read during the read transaction.

Application Information

Power-Supply Decoupling

To achieve best results, it is recommended that the power supply is decoupled with a 0.01 μ F or a 0.1 μ F capacitor. Use high-quality, ceramic, surface-mount capacitors, and mount the capacitors as close as possible to the VCC and GND pins to minimize lead inductance.

LDMOS RF Power-Amplifier Bias Controller

SDA and SCL Pullup Resistors

SDA is an open-collector output on the DS1870 that requires a pullup resistor to realize high logic levels. A master using either an open-collector output with a pullup resistor or a push-pull output driver can be used for SCL. Pullup resistor values should be chosen to ensure that the rise and fall times listed in the AC electrical characteristics are within specification.

Advanced Application

A circuit showing the implementation of current sensing using the DS1870 is shown under "Advanced Application".

Advanced Application with Current Sense

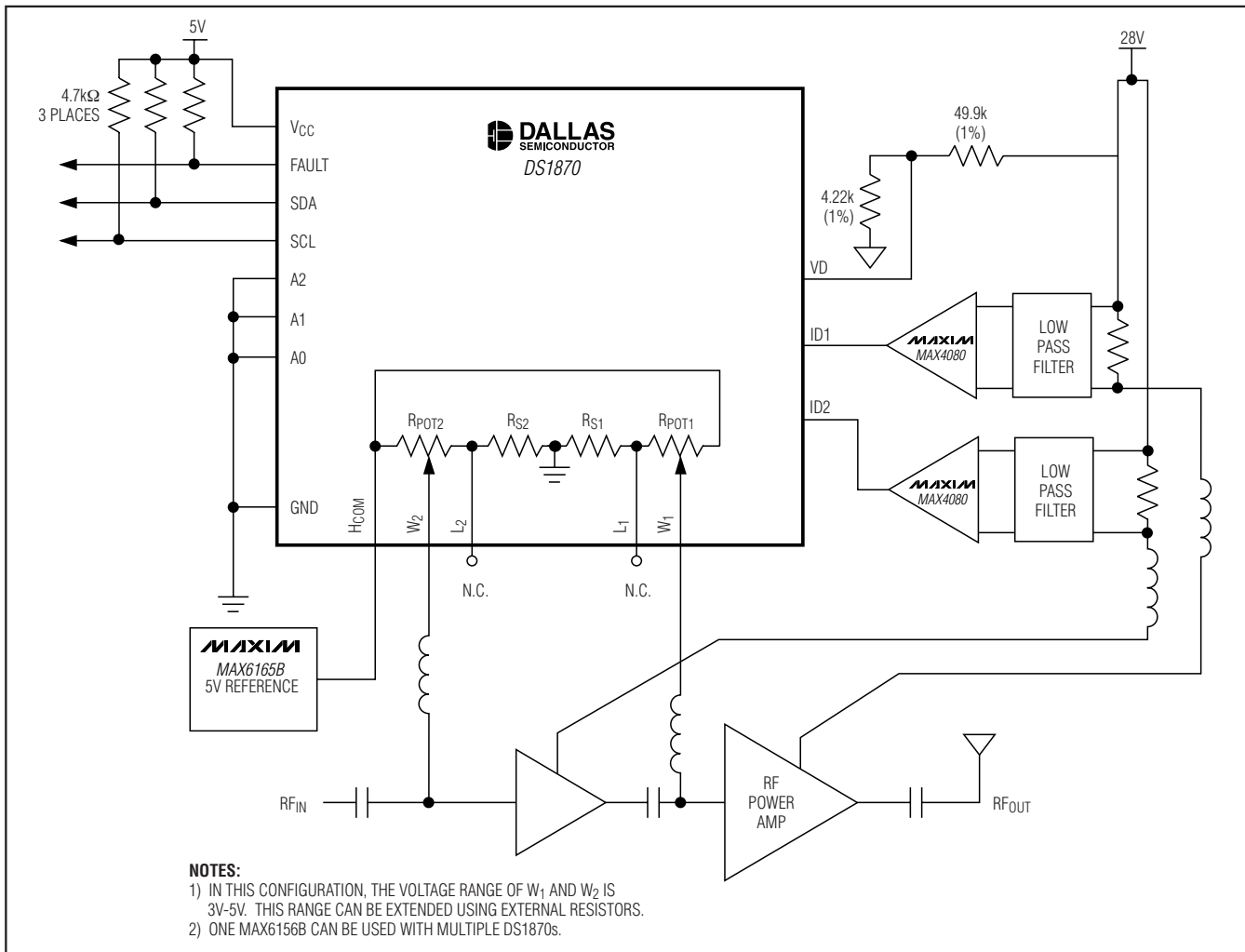

Chip Information

TRANSISTOR COUNT: 52,353
 SUBSTRATE CONNECTED TO GROUND

Package Information

For the latest package outline information, go to www.maxim-ic.com/DallasPackInfo.

Maxim cannot assume responsibility for use of any circuitry other than circuitry entirely embodied in a Maxim product. No circuit patent licenses are implied. Maxim reserves the right to change the circuitry and specifications without notice at any time.

28 **Maxim Integrated Products, 120 San Gabriel Drive, Sunnyvale, CA 94086 408-737-7600**